

Truing Tool TT-50

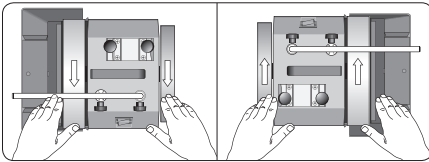

- *Trues the stone exactly round and flat.*
- *An easily operated built in feeding device leaves an even surface to the stone.*
- *By feeding the diamond more quickly you can leave a coarser surface and increase the steel removal rate of the grindstone.*
- *Convenient setting of the cutting depth using the Micro Adjust on the Universal Support.*

Positioning of Machine



Note Owners of older machines, which have a Universal Support without Micro Adjust, would need to set the depth manually.

Design

This unique and patented Truing Tool turns your grindstone exactly round and flat while it is mounted on the machine. The truing is guided by the Universal Support (1), which also guides the jigs. This ensures that the surface of the stone is always parallel to the tool fitted in the jig.

The tool has a built in feeding device (2) for convenient control of the diamond cutting tip (3) across the stone. You can set the desired cutting depth by means of a scale (4) on the Universal Support. A suitable depth is between 0.25–0.75 mm (0.01–0.03").

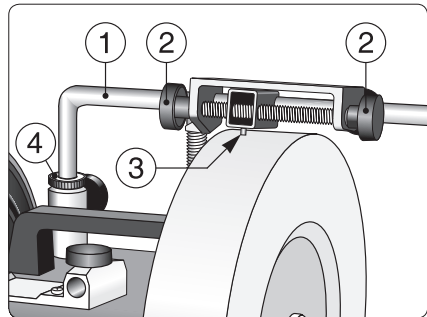

The cutting tip consists of diamond grains embedded in a cylinder of copper. The grains are positioned irregularly like "raisins in a cake". During use, the soft copper will be worn and the diamond grains will stick out as peaks on the copper surface. Worn grains will after a period of time be replaced by new ones. This design gives a long life to the tip.

Truing

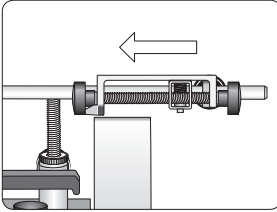

Set the height of the Universal Support so the Truing Tool can be positioned.

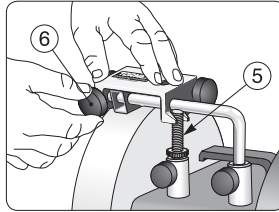

Press the Truing Tool towards the leg (5). Lock it with the locking knob (6).

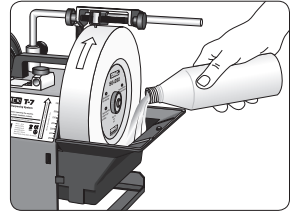

Start the machine and fill water in the trough.

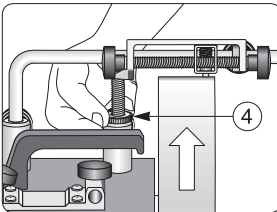

Lower the Universal Support with the Micro Adjust (4) until the cutter touches the highest spot on the stone.

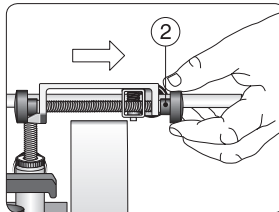

Stop the machine. Move the cutter sideways with one of the knobs (2), so it is outside the stone.

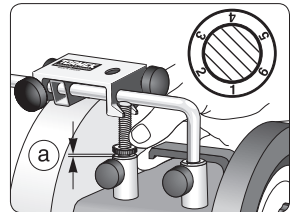

Set the desired cutting depth (a) by raising the Micro Adjust which is graduated for each 0.25 mm (0.01").

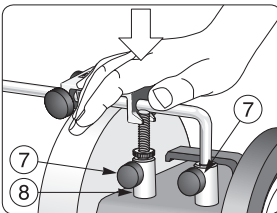

Press downwards so the Micro Adjust again rests on the sleeve (8). Lock with the two locking screws (7).

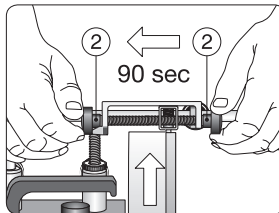

Start the machine. Feed the cutting tip by turning the two knobs (2) alternately. Use approx. 90 seconds to move across the stone.

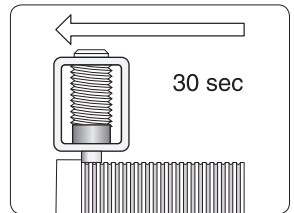

You can cause the stone to grind faster by feeding the tool faster. Take 30 seconds to cross the stone. Use max 0.25 mm (0.01") cutting depth.

- Max cutting depth 0.75 mm (0.03").
- Do not feed too slowly as vibrations can occur.
- True the grindstone immediately if you notice any unevenness. This will increase the life of your grindstone. Even a slight unevenness will automatically be increased if you continue grinding.
- The copper material between the diamond grains in the cutter tip will immediately wear down to a level just under the points of the diamonds. This can look as if the cutter tip is faulty, but this is normal.