

Multi Jig SVS-50



TURNING TOOLS

Square and skew chisels with straight or curved edges. Max width 32 mm (1¼").

Parting tools

Beading tools

Roughing gouges

Max width 50 mm (2").

CARVING TOOLS

Gouges, 25–50 mm (1–2").

Straight shanked or tapered.

Square and skew chisels

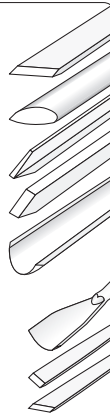

Positioning of Machine

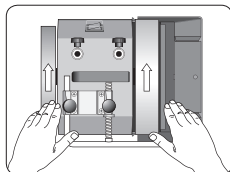

*Grinding direction:
away from the edge.*

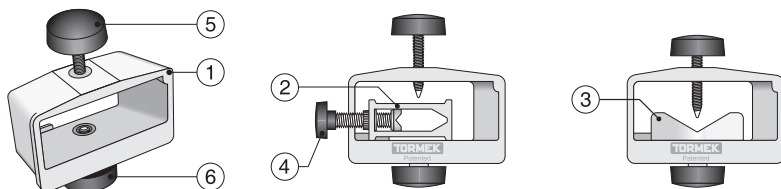

Design

This patented jig consists of a housing (1) and two interchangeable seats – one closed, (2) and one open, (3). The seats can swivel and be locked with the screw (6) at any skew angle between 0° and 45°. Skew chisels have symmetrical bevels on both sides. With this jig you mount the tool only once for grinding both the bevels. By turning the jig upside down you can grind both of the bevels symmetrically.

The closed seat has been developed for the precision sharpening of turning skew chisels with an oval or square section and with curved or straight edges. Since the chisel is mounted in the centre of the seat, the bevels are ground to exactly the same shape. The turning skew chisel is mounted with a side screw (4). Tool size 13 mm (1/2") to 35 mm (1 3/8"). It is also suitable for carving skew chisels longer than approx 110 mm (4 3/4").

The open seat, where the tool is fixed with a top screw (5), is used for tools which have the edge ground square across the shank, such as parting tools, roughing gouges and wide carving gouges. Both seats are mounted with a bottom screw (6), which also locks the chosen skew angle. A scale on each seat shows the skew angle.

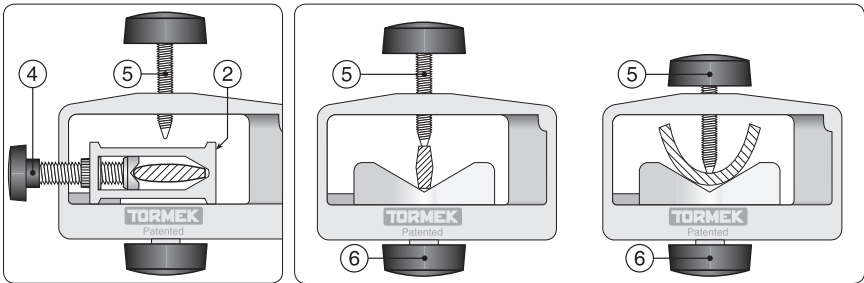

The closed seat (2) is for skew chisels. The tool is fixed with the side screw (4). The top screw (5) is not used.

The open seat is designed for tools which have the edge square across the shank. The tool is fixed with the top screw in the housing (5). As the seat can be turned, it can also be used for short skew chisels.

Grinding Direction

Grinding away from the edge with Universal Support placed horizontally is recommended. This gives you following advantages:

- With the lighter grinding pressure you can more easily control the operation. Especially advantageous when grinding small tools.
- As no water flows over the edge, it is easier to see where the grinding takes place.
- The rotation of the stone pulls the jig towards the Universal Support.
- No risk of vibration.

Turning Skew Chisels

Flat or Oval with a Straight Edge

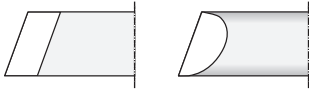

Here is shown the shaping of a flat skew, which has a rectangular section. The oval skew is done in the same way.

You can do the initial shaping either directly on the Tormek machine or on a bench grinder using the Tormek Bench Grinder Mounting Set BGM-100 (page 29). When you need to remove a lot of steel, e.g. when decreasing the edge angle or changing the skew angle, you can use a bench grinder which removes steel faster.

These three factors determine the geometry of a skew.

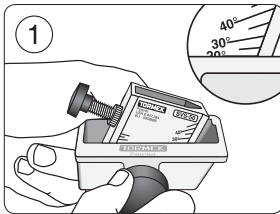

The setting of the jig to the skew angle, JS.

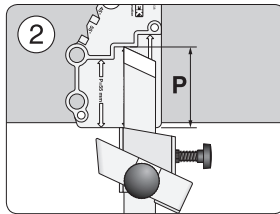

The protrusion of the tool in the jig, P.

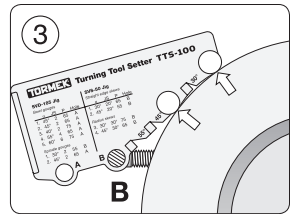

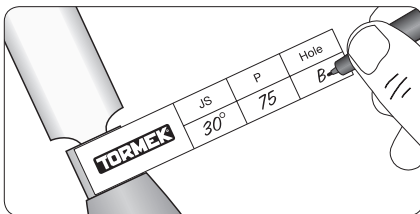

Universal Support position. Use hole B.

The Turning Tool Setter TTS-100 controls these factors. Select the profile you want from the chart on the next page and use the three factors, which will give that shape. Then note the settings on the Profile Label and put it on the ferrule. After the initial shaping you can exactly replicate your favourite shape at every sharpening in less than a minute.

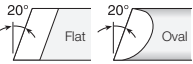
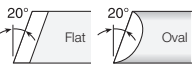

Note the settings on a Profile Label and put it in on the ferrule. A set of labels comes with the jig.

Selection Chart

1	Straight edges $\alpha=30^\circ$ 	JS 20° P 65 Hole B	For tight spots, detail work and finest finish. For professional level turners.
2	Straight edges $\alpha=45^\circ$ 	JS 20° P 55 Hole B	For broad application. Easier to control than a 30° edge angle.
3	Radius edges $\alpha=30^\circ$ 	JS 30° P 75 Hole B	For tight spots, detail work and finest finish. For professional level turners.
4	Radius edges $\alpha=45^\circ$ 	JS 30° P 65 Hole B	For broad application. Easier to control than a 30° edge angle.

These geometries, i.e. the shape and edge angle, are recommended by experienced woodturners and recognized woodturning workshops around the world, e.g. Craft Supplies in USA and Drechselstube Neckarsteinach in Germany.

Since a skew can have an unlimited number of combinations of skew angles, shapes and edge angles, a new tool has a more or less a different shape than any of the shapes on the chart. Therefore, you first need to shape your tool to one of the shapes on this chart. Then the following sharpenings will be an easy task and done in less than a minute.

Note Stick to the shape you have selected and do not switch from one shape to another. Then you will get the full benefit of the Tormek TTS-100 Setter, since you can instantly replicate exactly the same shape every time. Should you need a different shape, then buy another tool and grind it to your alternative shape. This way of working will give you more time for turning and fewer interruptions for shaping and sharpening.

Tip Like many professional turners you should put a curve on the edge. This is easily done with the SVS-50 jig (page 103). Shaping a skew with a curved edge is faster since the reduced area in contact with the grindstone results in a higher grinding pressure.

Position of the Universal Support

You can work with the Universal Support placed either horizontally with the stone running away from the edge or vertically so the stone runs towards the edge.

In the horizontal position the rotation of the grindstone pulls the jig towards the Universal Support. In the vertical position, the grinding pressure is increased by the rotation of the stone but you must watch that you keep pressing the jig firmly towards the Universal Support to ensure that the edge does not catch the stone.

In this instruction, we show the horizontal position. When much steel needs to be removed for the initial shaping, you could beneficially work with the Universal Support placed vertically. For future sharpenings, you should always work in the horizontal position so the rotation of the stone pulls the jig towards the Universal Support and that you eliminate the risk that the edge catches into the stone.

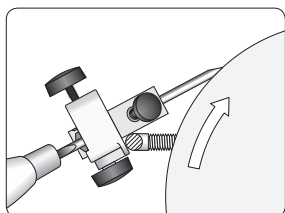

Horizontal mount. The stone runs away from the edge.

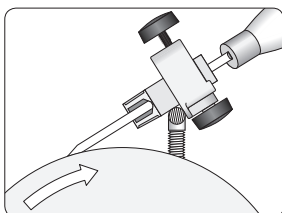

Vertical mount. The stone runs towards the edge.

Round Off the Corners On a Flat Skew

Before shaping a *flat* (rectangular) skew for the first time, you should for two reasons, check that the corners are rounded off. Firstly, the tool works more smoothly on your lathe tool rest and secondly the skew lines up more easily in the seat of the jig.

The rounding off can be done on your Tormek machine. You can even polish the surfaces on the honing wheel for the lowest possible friction on the tool rest of your lathe.

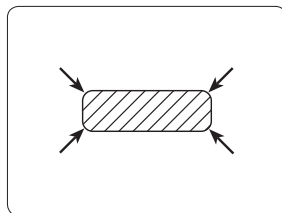

A flat skew should have rounded off corners.

Settings

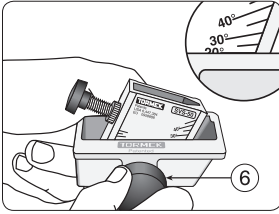

Set the jig and lock the position securely with the bottom screw (6).

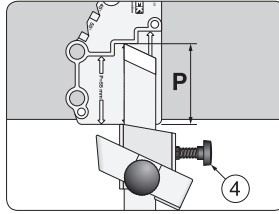

Mount the tool. Lock with the side screw (4).

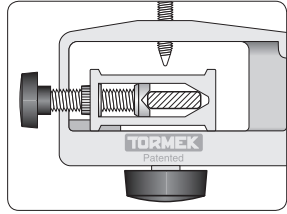

Check that the tool is aligned so the shape later on will be exactly replicated.

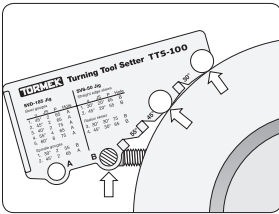

Horizontally

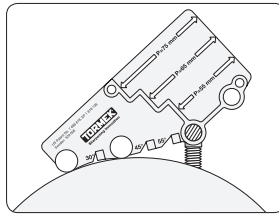

Vertically

Set the Universal Support. You can work with the Universal Support mounted either horizontally or vertically (page 99). Use the inner hole of the setter. Both metal discs must touch the stone.

The closed seat

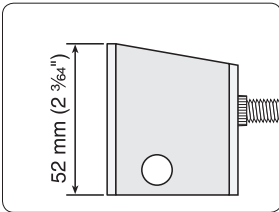

Current design

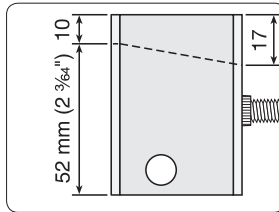

Earlier design

This seat has been re-designed (2006). It is now 10 mm shorter and also slanted in order to permit the sharpening of shorter tools. If you have the longer seat, you should trim it to 52 mm (2 3/64").

Shaping

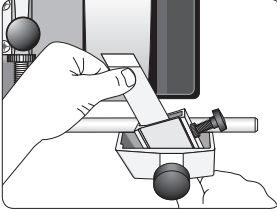

Lift the tool and then move it sideways during the sharpening. Do not slide the tool. Press with your thumb close to the edge.

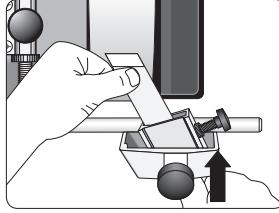

Apply forward pressure on the handle side to compensate for the force of the stone against the tool.

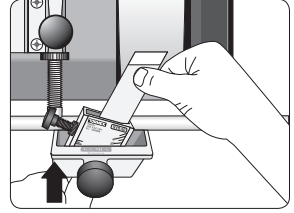

Turn the jig around and shape the other side. Apply forward pressure on the handle side.

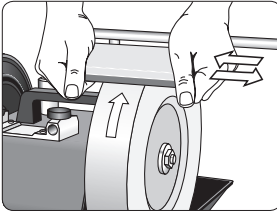

Activate the grindstone during the grinding process with the coarse side of the Stone Grader SP-650.

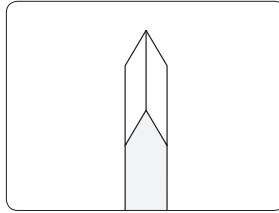

Grind until the bevels are symmetrical. If necessary grind the first side again.

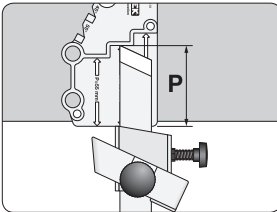

When the desired shape is achieved, check that the protrusion has not decreased during the shaping. If so, re-position the tool to the right protrusion and then complete the shaping. By doing so, you ensure that you will exactly replicate the edge geometry at future sharpenings.

Shaping wide chisels

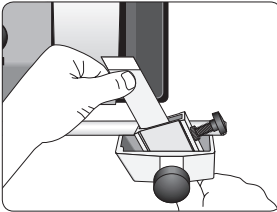

When shaping a wide chisel, you can increase the efficiency of the stone by grinding half the width at a time. The grinding pressure will increase, which makes the stone grind faster.

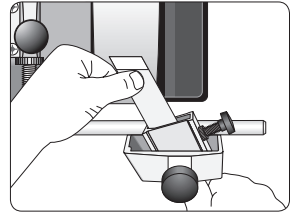
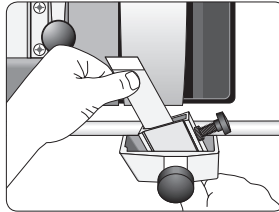

Complete the sharpening with the entire bevel on the stone. Lift the tool to move it sideways.

Sharpening

Once you have created the shape of the edge it is an easy task to quickly re-sharpen the tool. Do the three settings noted on the Profile Label carefully and you will obtain exactly the same shape every time even when the stone wears and decreases in diameter.

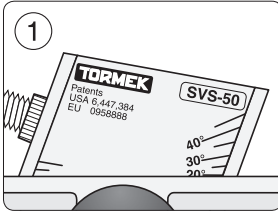

Set the jig, JS.

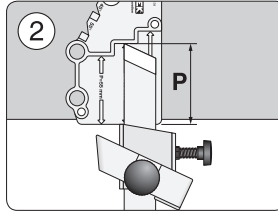

Mount the tool with a fixed protrusion, P.

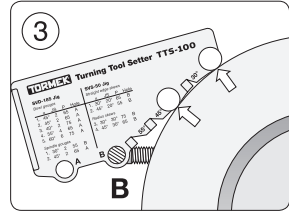

Set the Universal Support. Use hole B.

Honing

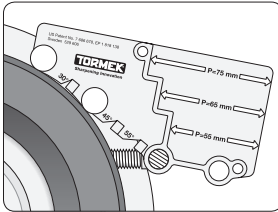

Move the Universal Support to the honing wheel and position identically with the Setter.

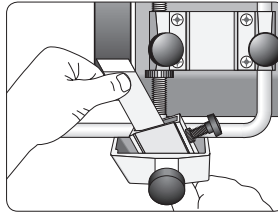

Hone both the sides alternately until the burr is removed and the bevels are polished to a mirror finish.

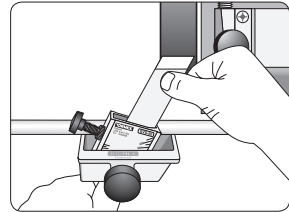

Flat or Oval Skews with a Curved Edge



You can put a curved (convex) edge on both your flat and oval skews. You pivot the jig with the tool on the Universal Support to create the curve. This curved edge has certain advantages and has been popularized amongst others by the Australian professional woodturner Richard Raffan. He prefers a slightly curved edge, which is shown in full scale on the next page.

To achieve this shape, you need to set the SVS-50 jig on 30° instead of 20° for the straight edge shape. Even here, you will need to remove quite a bit steel, which can take 10–20 minutes depending on the original shape. But again, this is a once only task, from which you will benefit at future sharpenings.

Since the contact area against the grindstone on a convex edge is smaller than on a plain edge, the resulting grinding pressure is higher when applying the same force on the tool. (The grinding pressure is the force you apply onto the tool divided by the grinding area.)

A certain grinding pressure is required to maintain an active grindstone surface so it does not become glazed. When shaping or sharpening a skew chisel with a straight edge, which has a large grinding area, you therefore need to re-activate the grindstone frequently with the Stone Grader SP-650.

Since the grinding pressure is higher – even with the same force applied on the tool – on a skew with a convex edge, the grindstone activates itself and therefore grinds more effectively. This is why a skew with a convex edge is shaped faster than a skew with a straight edge.

Grinding area and grinding pressure

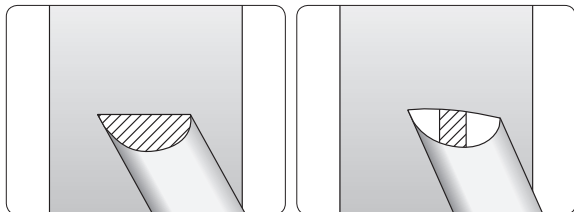

Straight edge. Large grinding area. Same as the entire grinding bevel. Low resulting grinding pressure. Grindstone requires activating.

Convex edge. Smaller grinding area. Higher resulting grinding pressure. The grindstone works more effectively.

Principle of creating the curve

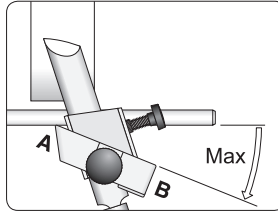
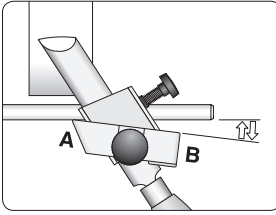

Pivoting the jig on the beveled corner of the jig (A) creates the curve. Do not turn the jig more than the max. shown so the seat rests on the Universal Support all the time.

Shaping and sharpening

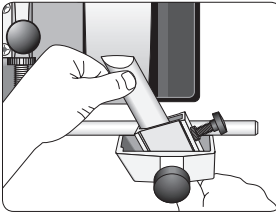

Pivot the jig so you create the shape of the edge.

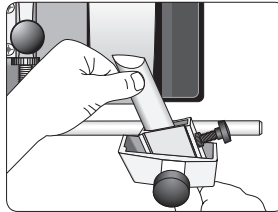

Watch that you do not grind too much on the long point.

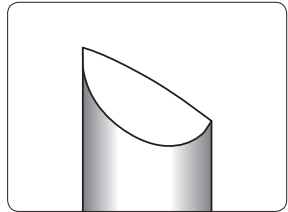

This is a suitable shape (full scale) for a 19 mm (3/4") oval skew.

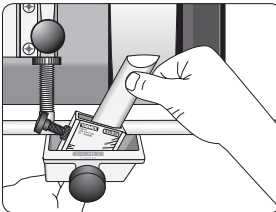

Turn the jig around and shape the other side.

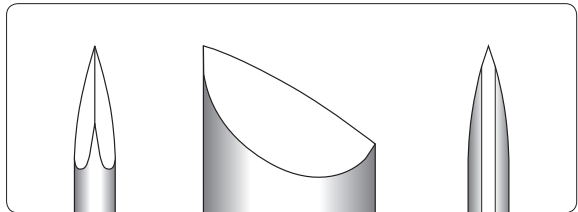

Grind until the bevels are symmetrical. If necessary, grind the first side again.

Honing

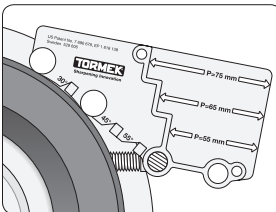

Move the Universal Support to the honing wheel and position identically with the Setter.

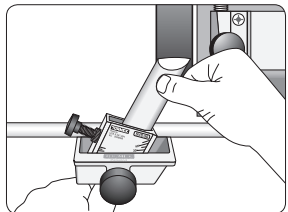
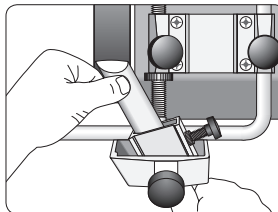

Hone both the sides alternately until the burr is removed and the bevels are polished to a mirror finish.

Customized Profiles

You can also sharpen skews with different geometries other than the standard shapes provided by the TTS-100 Setter. This is the way you can replicate an existing edge geometry on a skew with a straight edge.

1. Mount the tool with a 65 mm protrusion using the TTS-100 Setter.
2. Set the skew angle as shown below.

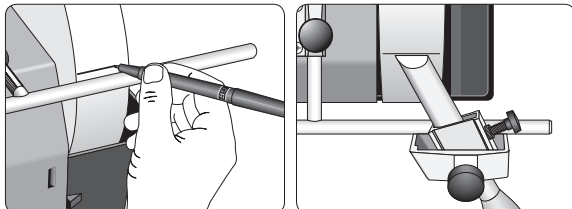

3. Set the edge angle with the Universal Support. Use the *Marker Method* (page 41).
4. Note the protrusion (P) and the jig setting on the recipe label, which comes with the jig. Put the label on the ferrule. Protect it with clear varnish.

When resharpener the edge angle, you should use the *Spacer Block Method* (page 41).

Tip If the geometry does not differ too much from the shapes the TTS-100 offers, you should consider changing the shape to the TTS-100 shape for easier replication in the future.

Parting and Beading Tools

The Open Seat is Used

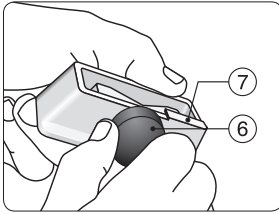

Lock the seat with the bottom screw (6) in the straight position (0°). The seat should touch the stop (7).

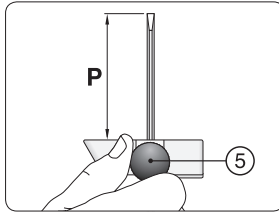

Mount the tool protruding (P) 75–100 mm (3–4") and lock it with the top screw (5).

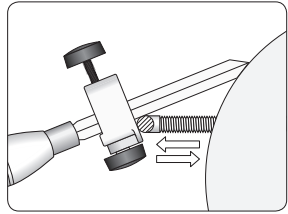

Set the edge angle by adjusting the Universal Support. When replicating an existing angle, use the Marker Method, (p 41).

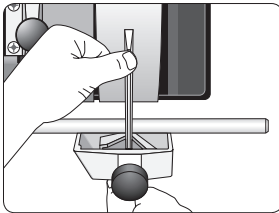

Press with your fingers close to the edge for best control while your other hand ensures that the tool is vertical.

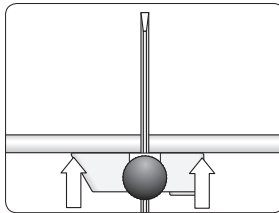

Ensure that the entire flange of the jig is in contact with the Universal Support

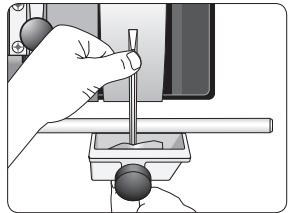

When the first side is ground then turn the tool around and grind the other side.

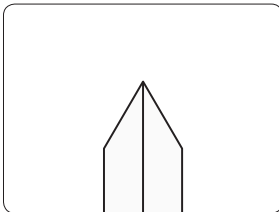

Grind until the bevels are symmetrical. If necessary grind the first side again

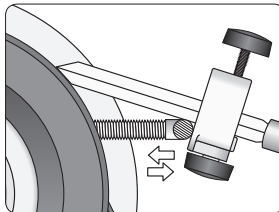

Honing. Move the Universal Support to the honing wheel side and hone the bevels with the tool still mounted in the jig. Set the Universal Support so that you get the same honing angle as the grinding angle. Use the Marker Method.

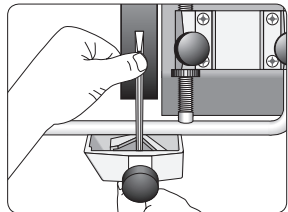

Roughing Gouges

The Open Seat is Used

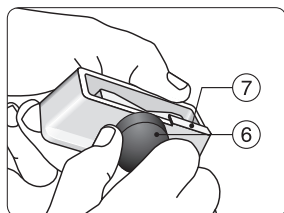

Lock the seat with the bottom screw (6) in the straight position (0°). The seat should touch the stop (7).

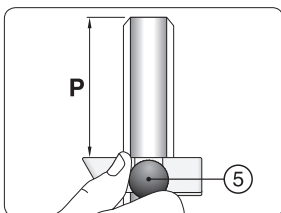

Mount the gouge protruding (P) 75–100 mm (3–4") and lock it with the top screw (5).

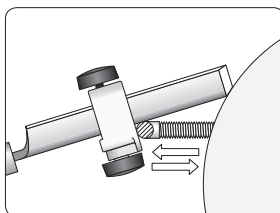

Set the edge angle by adjusting the Universal Support. When replicating an existing angle, use the Marker Method, (p 41).

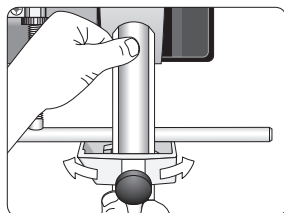

Roll the gouge on the Universal Support while you slide it across the stone so that the stone wears evenly.

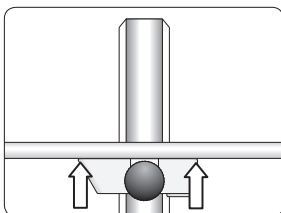

Ensure that the entire flange of the jig is in contact with the Universal Support.

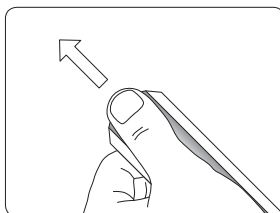

Grind until you can feel the burr along the entire edge.

Honing

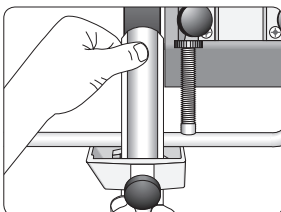
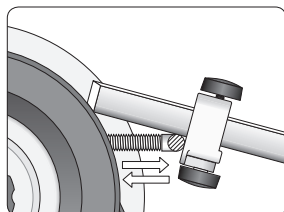

Move the Universal Support to the leather honing wheel.hone and polish the bevel with the tool still mounted in the jig. Set the Universal Support so that you have the same honing angle as the grinding angle. Use the Marker Method.

Carving Gouges with a Straight Shank

The Open Seat is Used



The Principle

Use the technique as described in the chapter *Sharpening Techniques for Carving Gouges and V-tools* on page 20.

Edge Angle

As described in the chapter above on page 24, the choice of edge angle is very important for a carving gouge. The method of setting the jig for a certain angle depends on whether you want to replicate an existing edge angle or if you want to put a new edge angle on your tool.

When replicating an existing edge angle, you should use the *Marker Method*, which is described on page 41. If you want to put a new edge angle to your tool, you can either set the angle by eye or you can use the AngleMaster (page 142).

Shaping the edge

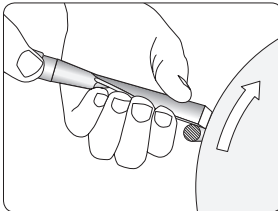

Shape the edge by resting the tool on the *Universal Support* placed horizontally and close to the stone.

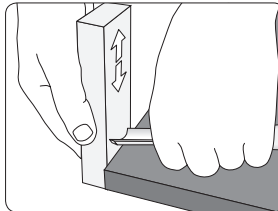

Flatten and smooth the blunt edge with the fine side of the *Tormek Stone Grader, SP-650*.

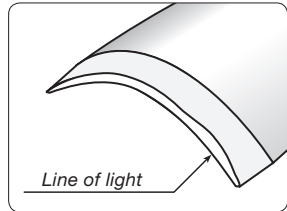

The blunt edge now appears as a *line of light*, which is your guide on where to grind.

Mounting the tool and setting the jig

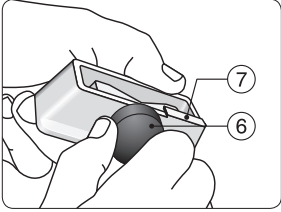

Lock the seat with the bottom screw (6) in the straight position, (0°). The seat should touch the stop (7).

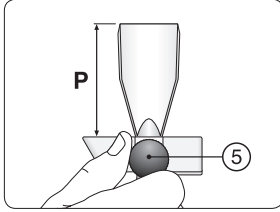

Mount the gouge protruding (P) 75–100 mm (3–4") and lock it with the top screw (5).

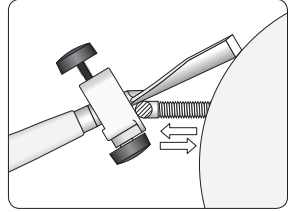

Set the edge angle by adjusting the Universal Support. When replicating an existing angle, use the Marker Method.

Grinding

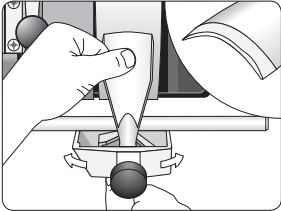

Always grind where the line of light is thickest whilst rolling the tool on the Universal Support.

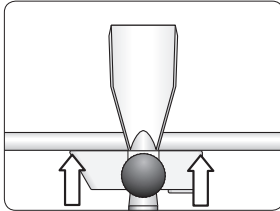

Ensure that the entire flange of the jig is in contact with the Universal Support.

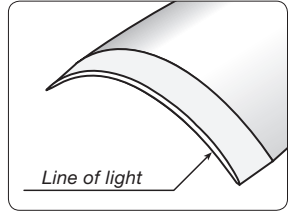

Check frequently where the grinding is taking place. Grind until you have a thin and even line of light.

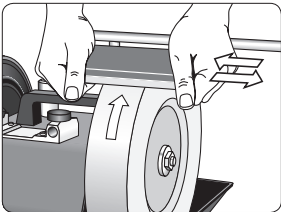

Grade the grindstone for fine sharpening with the fine side of the Stone Grader SP-650.

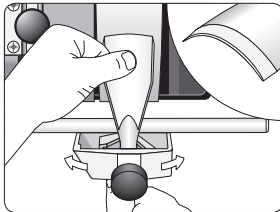

Continue grinding. Check the result frequently.

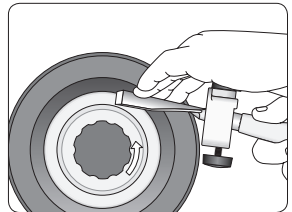

Remove the burr on the leather honing wheels so that you can more clearly observe the line of light.

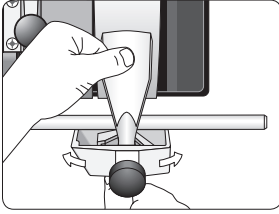

Now sharpen again with a very light pressure. Check frequently to ensure that you do not over-grind.

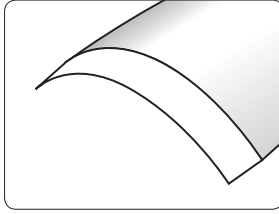

Stop sharpening immediately when the line of light disappears, which is a sign that the edge is sharp.

Important It is very easy to be misled by the burr and mistake the burr for the line of light! Therefore you must remove the burr frequently during the finishing of the grinding operation, so you clearly can watch the progress of a gradually thinning the line of light.

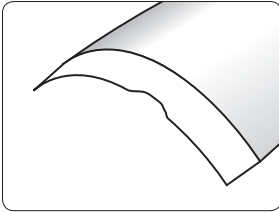

It is easy to over-sharpen the edge at the end of the process. If this happens, you need to re-shape the edge and start again from the beginning.

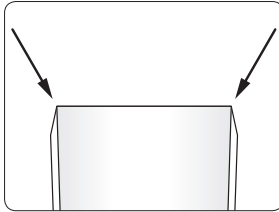

Be careful when you grind at the sides of the tool so that you do not round off the corners. Woodcarving tools should have sharp corners!

Honing

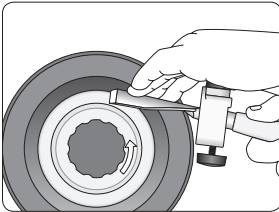

Keep the tool in the jig and hone and polish the inside on the Profiled Leather Honing Wheel LA-120.

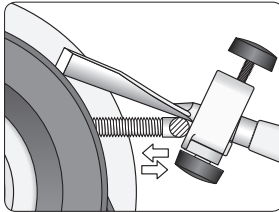

Hone and polish the bevel. Set the Universal Support so that the honing angle is the same as the grinding angle. Use the Marker Method. Hone away the burr and polish the bevel to a mirror finish.

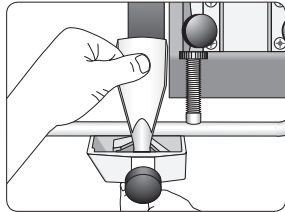

Testing the Sharpness

Keep the tool mounted in the jig and test the sharpness. Push the edge across the fibres in a piece of wood. The edge should cut easily and leave a smooth surface without tearing the fibres. Since the tool is still mounted in the jig and the Universal Support is left in its position, you can if necessary easily go back and continue the honing.

Square Carving Chisels

The Open Seat is Used



The min length of blade for this jig is approx 100 mm (4") at 25° edge angle. For shorter blades, down to 75 mm (3"), you use the SVS-38 jig (page 68).

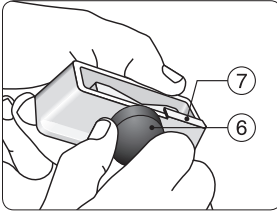

Lock the seat with the bottom screw (6) in the straight position (0°). The seat should touch the stop (7).

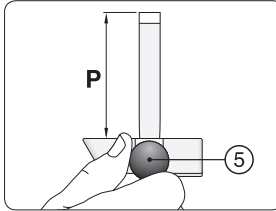

Mount the chisel protruding (P) min 100 mm (4"). Lock with the top screw (5).

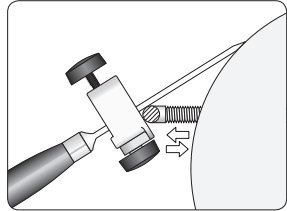

Set the edge angle by adjusting the Universal Support. When replicating an existing angle, use the Marker Method.

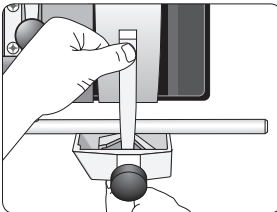

Sharpen the first side. Press with your thumb close to the edge for best control. Lift the tool and then move it sideways so that the stone wears equally. When a burr has developed on the entire edge, turn the jig around and sharpen the other side.

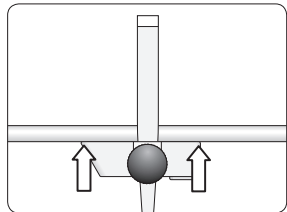
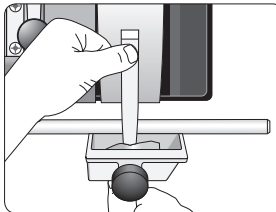

Ensure that the entire flange of the jig is in contact with the Universal Support.

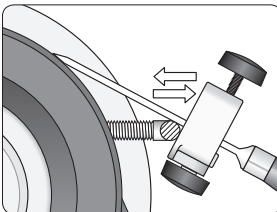

Honing. Keep the tool in the jig and move to the leather honing wheel. Set the Universal Support so that the honing angle is the same as the grinding angle. Use the Marker Method. Hone away the burr and polish the bevels to a mirror finish.

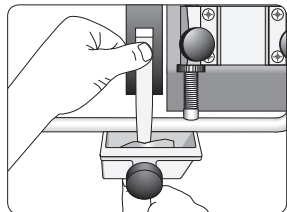
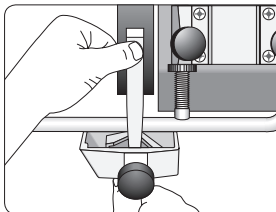

Carving Skew Chisels

The Closed Seat is Used

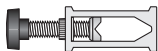

These tools are manufactured with a skew angle of approx. 25°. You can sharpen your chisel either with the existing skew angle or you can shape it to a new skew angle of your choice.

For using this jig the chisel must have a certain min. length, which depends on the edge angle and the skew angle. At a 25° edge angle and a 25° skew angle the min length of blade is approx. 105 mm (4 1/8"). The shape of the shank must also be able to be locked in the seat, otherwise use the open seat.

Setting the existing skew angle

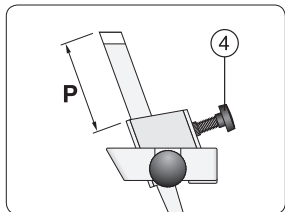

Mount the tool protruding (P) 50–75 mm (2–3") and lock it with the side screw (4).

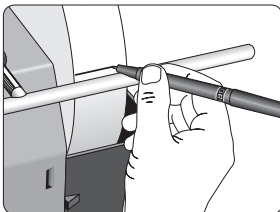

Mark a line across the stone guided by the Universal Support. Use a water proof pen if the stone is wet or a pencil.

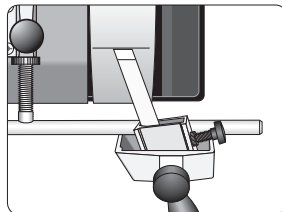

Put the tool on the Universal Support and turn it until the bevel is parallel to the line. Tighten the bottom screw (6).

Setting a new skew angle

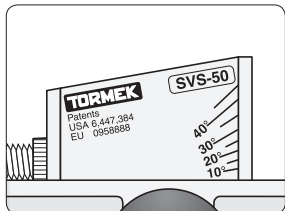

A scale on the seat enables you to set the desired skew angle.

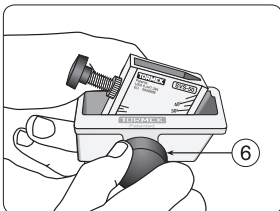

Lock the position with the bottom screw (6).

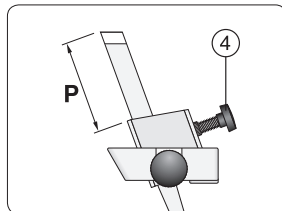

Mount the tool protruding (P) 50–75 mm (2–3") and lock it with the side screw (4).

Setting the edge angle

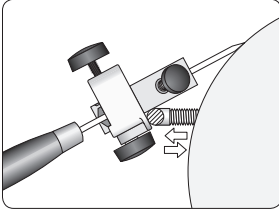

Set the edge angle by adjusting the Universal Support. When replicating an existing angle, use the Marker Method. When setting a new angle you can use the AngleMaster.

Grinding

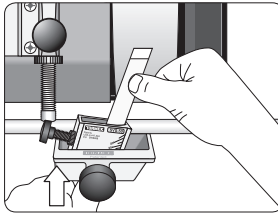
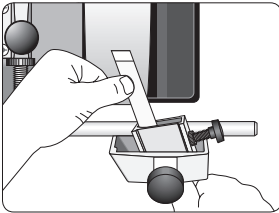

Grind the first side. Press with your thumb close to the edge for the best control. Lift the tool and then move it sideways. When a burr has developed on the entire edge, turn the jig around and grind the other side.

Grindstone Condition

Usually carving chisels only need fine sharpening. Therefore you normally grade the grindstone to a finer grit with the Stone Grader SP-650 (page 140). When you need to *shape* the chisel, you use the normal fast grinding condition of the grindstone.

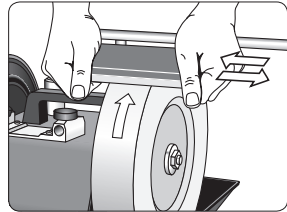

Honing

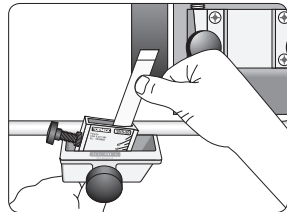
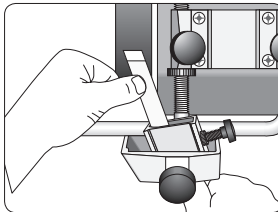
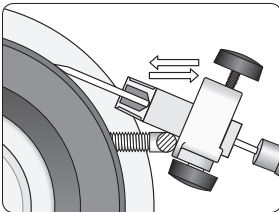

Keep the tool in the jig and move to the leather honing wheel. Set the Universal Support so that the honing angle is the same as the grinding angle. Use the Marker Method. Hone away the burr and polish the bevels to a mirror finish.