

# Square Edge Jig SE-77 (SE-76)

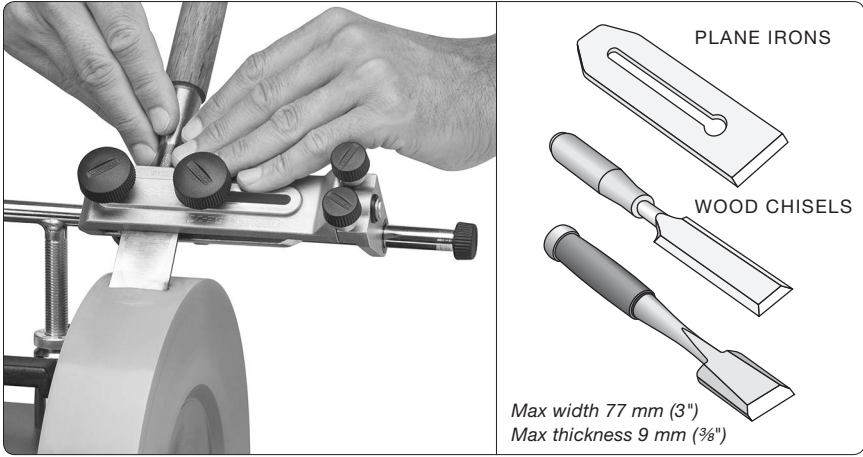

*SE-77 is a further development of SE-76. The jig now has an adjustable side.*

## Positioning of Machine

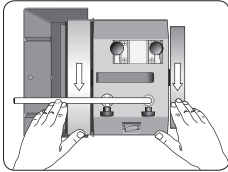

*Grinding direction:  
Towards the edge.*

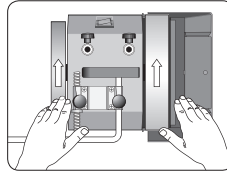

*Honing direction:  
Away from the edge.*

## Design

See illustration on the next page. The jig comprises an upper base with a lower clamp and two locking knobs for fixing the tool. The jig slides on the Universal Support on nylon bushings across the grindstone. The edge angle is set with the Micro Adjust (3) on the Universal Support (4).

There are two safety stops to prevent the tool from slipping off the stone when grinding. One inner stop (1) to be positioned according to the width of the tool and one outer stop (2) mounted on the end of the Universal Support.

The jig lines up the chisel to its upper flat side, making it easier to mount it correctly (not twisted). Conventional jigs need manual alignment.

The lower clamp has a ridge in the centre enabling shorter tools with a tapered shank to be firmly mounted, e.g. Japanese chisels. The upper base, which lines up the tool, is designed so the clamping pressure is distributed to the ends and the tool mounts firmly without a heavy tightening of the knobs.

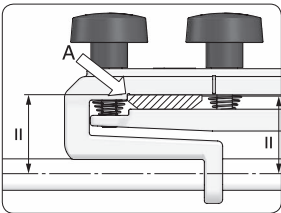
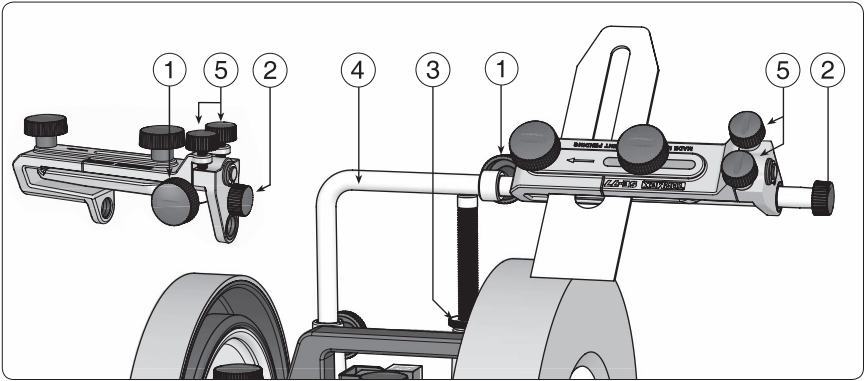

The jig lines up the chisel to its upper and flat side. Thanks to the shoulder (A) it is easy to mount the tool correctly at 90°.

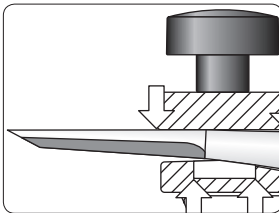

The clamping pressure from the ridge in the centre is distributed to the edges. This gives a firm mounting, even with tapered chisels.

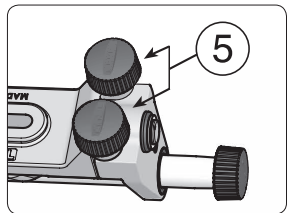

SE-77: The two smaller adjustment screws (5) are used if you need fine adjustment to achieve a 90° angle, or if you want a slightly convex shape (page 125).

## Preparations

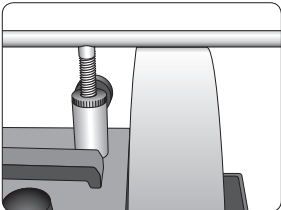

Before you start grinding, check that the stone is true by letting the Universal Support touch the stone.

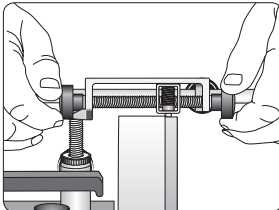

If necessary, true it with the Truing Tool TT-50 so the surface is flat and parallel to the Universal Support.

## Flatten and hone the back of the tools

To achieve a really sharp and durable edge, both of the two converging surfaces must be smooth. If we sharpen and hone the bevel to perfection but the back is not equally flat and smooth, you will never achieve a satisfactory result. On most new tools, the back has visible grooves from the manufacturing process. These should be removed and the surface honed and polished. This work only needs to be done once, when you start using the tool. It is a good investment in your quality tool and will last its lifetime.

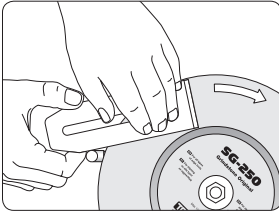

Carefully position the tool against the stone. The edge must not touch the stone before the heel! Flatten the back of the tool by holding it flat to the grindstone while moving it slightly. Otherwise the tip can cut into the wheel and be rounded off. Let the side of the tool rest on the Universal Support, which should be placed close to the stone as shown. You do not need to smooth the tool more than 25–30 mm (1–1¼") from the edge.

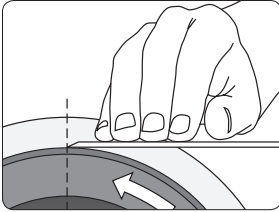

Working freehand, hone and polish the surface on the leather honing wheel. Hold the tool so it is a tangent to the wheel.

### SE-77 and SE-76

### SE-77: Mounting the tool

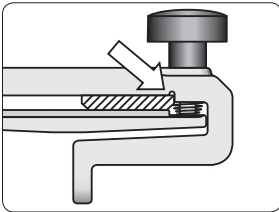

Tools with parallel sides must rest on the shoulder. For mounting tools without parallel sides, see page 124.

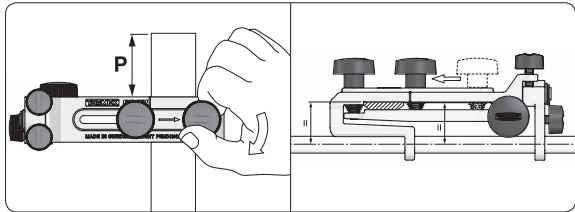

Mount the tool protruding (P) approx. 50–75 mm or 2–3". Lock the tool by tightening the movable knob about 5 mm from the tool.

### SE-76: Mounting the tool

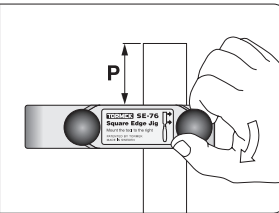
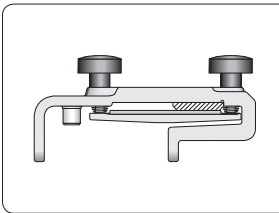

Open the clamp to the thickness of the tool and approximately parallel to the base. Mount the tool protruding (P) approx. 50–75 mm (2–3"). Lock the tool by tightening the knob nearest to the tool only.

### Setting the safety stops

The safety stops ensure security when using the stone's full width and should be used when sharpening plane irons, since these are partly moved outside the stone. The inner stop (A) is removed when sharpening blades wider than 60 mm or 2 3/8".

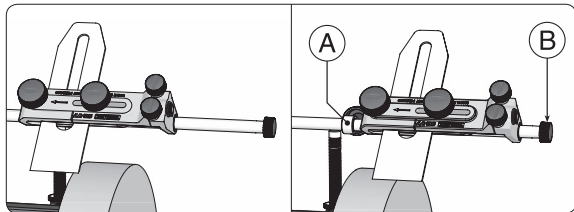

First mount the inner, movable stop (A) so the tool rests with approx. 6 mm or 1/4" on the stone. Then mount the outer stop (B), which is fixed and independent of the tool width.

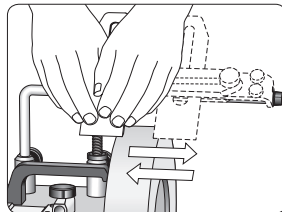

Move the tool continuously between the two stops. Spend more time sharpening the sides.

### Setting the edge angle

The height of the Universal Support determines the edge angle. This can be set in two ways. Either you can exactly replicate the existing angle using the Marker Method or you set to a new angle according to your choice using the Tormek AngleMaster WM-200.

#### Sharpening an existing edge angle

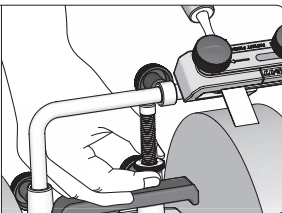
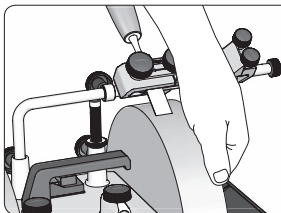
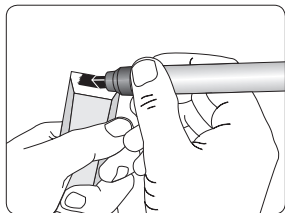

Colour the bevel with a marker. Turn the grindstone by hand and check where the grinding will take place. Adjust with the Micro Adjust until the stone touches the entire bevel from the tip to the heel.

#### Sharpening a new edge angle

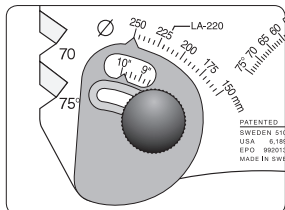

Set the AngleMaster WM-200 to the diameter of your stone.

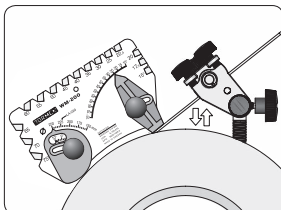

Set the height of the Universal Support with the Micro Adjust.

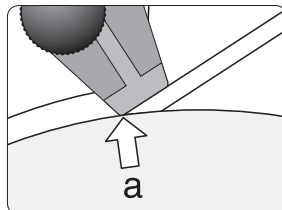

Note! The entire base should rest on the tool with the corner (a) on the stone.

## Sharpening

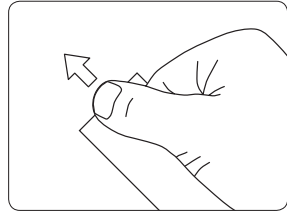
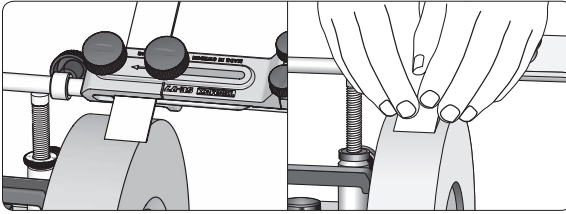

Move the tool sideways to use the whole width of the stone. Do not move more than approx. 2 mm ( $\frac{5}{64}$ " ) outside the stone. Press with your fingers close to the edge for best control. A higher grinding pressure means faster steel removal. Lighten the pressure at the end of the sharpening and you will obtain a finer surface.

Sharpen until a burr develops on the entire bevel. You can feel it with your finger.

**Important** You control with your hands – the pressure and grinding time – where the grinding takes place. Check the shape frequently and grind more where it is needed.

## Japanese Chisels

These differ in shape from the Western style chisels. The rough shape from the forging is retained without machining, the sides are usually not parallel and the blades are shorter. This means that you cannot use the alignment shoulder in the jig for an exact 90° alignment. The clamp is designed so tools with a tapered shank can also be firmly mounted (page 121). Be cautious when sharpening Japanese chisels! Compared to longer Western style chisels there is a limited amount of available steel, so you should set carefully to minimize the removal of expensive steel. The back has a hollow, which moves closer to the edge at each sharpening. After some sharpenings you might need to flatten the back, so the hollow does not reach the edge. Then use the side of the stone.

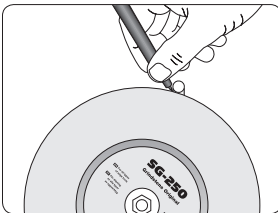
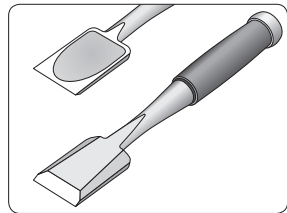

Draw a pencil line on the stone using the Universal Support as guide.

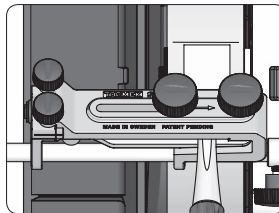

Align the tool to the line when mounting.

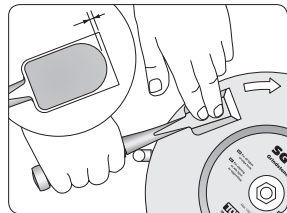

Ensure that the hollow does not reach to the edge. If necessary, flatten the back on the side of the grindstone. **Important!** Bring the tool to the stone carefully when flattening the back. The edge must not touch the stone before the heel.

### Factors that influence the result

To get a 100% straight edge when sharpening wide tools such as a plane iron, you need to pay attention to a couple of factors that influence the result. The grinding jig gives the tool a constant edge angle towards the stone but the shape achieved depends on how much *pressure* you apply on the right or left side. Also the *time* you spend sharpening on each side influences the shape.

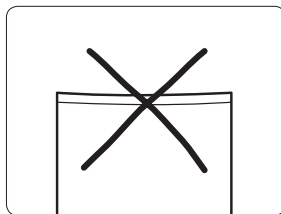

If you press equally on both sides and move the tool evenly across the stone, you will get a concave and not a straight edge. This is because the middle part is exposed to a longer sharpening time than the sides. Compensate for this effect by spending more time sharpening on the sides.

### Camber Shape

Most types of plane irons should have a slight convex shape or a camber. The degree of camber depends on type of plane and should be approximately the same as the thickness of the shavings. The camber (c) varies from 0.8 mm ( $\frac{1}{32}$ " ) for a jack plane down to 0.05 mm (0.002" ) for a smooth plane.

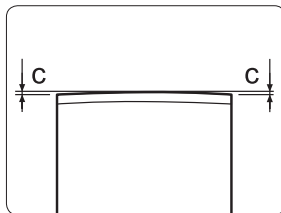

The camber is achieved by pressing harder on the sides. A longer protrusion of the blade in the jig will facilitate this effect, as most plane irons are a bit flexible. On a thick, stiff tool you create the camber shape by spending more time sharpening on the sides.

### SE-77 Adjustment screws

For tools with a larger convexity you can use the adjustments screws, see below. If you need additional convexity, sharpen free hand with the Tool Rest SVD-110.

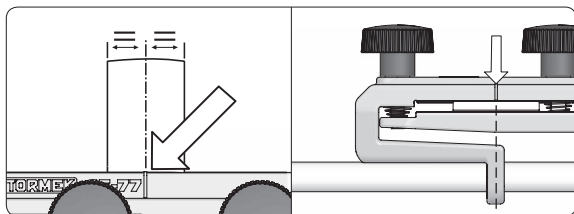

Center the tool under the jig's center line, marked with a line. Ensure that the tool is mounted perpendicularly by drawing a line along the Universal Support (page 124).

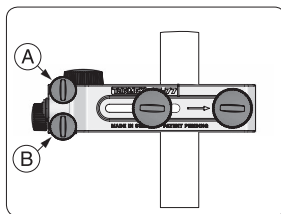

Loosen equally on the adjustment knobs A and B. The side then gets a pendulum motion. The more you loosen the knobs, the greater pendulum motion you get, which increases the convexity.

## SE-77 Fine adjustment

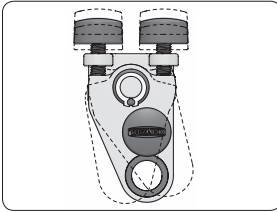

The adjustment screws create a movable side which allows fine adjustment. They can be used if you do not get a 90° angle.

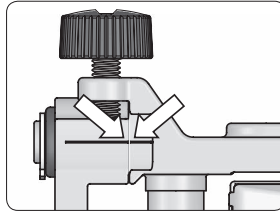

When the lines meet, the jig is in its neutral position.

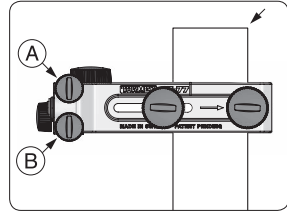

For increased sharpening pressure on the tool's right side, loosen knob A and tighten knob B. Do the opposite for increased sharpening pressure on the left side. Adjust approximately ¼ turn until you get a desired result.

## Finer Surface with the Stone Grader

You can refine the tool surface by grading the grindstone with the fine side of the Tormek Stone Grader SP-650. Pressing the Stone Grader firmly towards the grindstone refines the grindstone surface so it acts like a 1000 grit stone. If you are replicating an established edge angle, you can go directly to this finer surface of the stone.

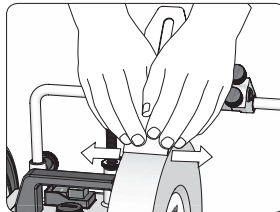
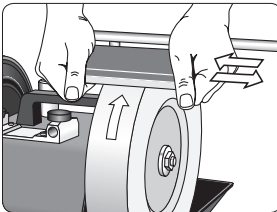

Press the fine side of the Stone Grader onto the stone for about 45 seconds. Use a fair amount of pressure.

Use the same setting and fine sharpen for 30–40 seconds. Do not press too hard.

## Honing on the leather honing wheel

Turn the machine around so that the honing wheel rotates away from you. Move the Universal Support to the honing wheel side and mount horizontally. Set to the same honing angle as the grinding angle. Use the *Bevel Marker Method* or the *AngleMaster WM-200* for the setting, see page 123. Remember to change the AngleMaster's diameter to Ø 220 mm. The jig gives you full control of the honing angle on the T-8 model.hone the back of the tool without the jig.

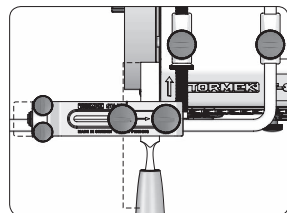

The safety stops are not used when honing – they are designed for use on the grindstone. Therefore, check that you do not slide the jig too far sideways. A part of the blade must always be in contact with the wheel.

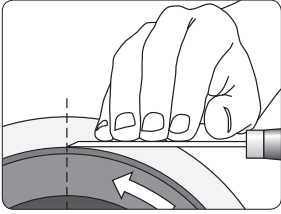

*Hone the back free hand. Hold the tool so that it is at a tangent to the wheel.*

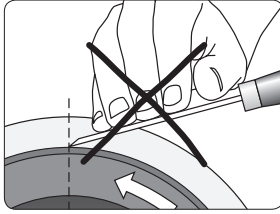

*Do not hold the tool at a steeper angle than the tangent! The tip will be rounded off.*

### Secondary Bevel?

Some people recommend that you should put a secondary bevel (or microbevel) on your plane irons and wood chisels. The reason is that the honing work after the grinding is quicker since you do not need to hone the entire surface of the bevel, just the smaller new bevel at the tip.

For wood chisels there is a drawback with a secondary bevel since you do not have the support of the large original bevel to control the cutting in the wood.

Since the grinding and honing of the entire bevel with the Tormek method is an easy and fast operation, there is no need for a secondary bevel. With a single bevel, you can set exactly the angle that you want and easily maintain it at every grinding and honing.

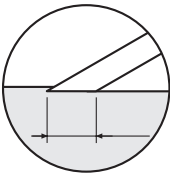

*Support length with a monobevel.*

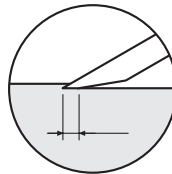

*Reduced support length with a secondary bevel on a wood chisel.*

### Edge Angle

Plane irons, wood chisels and spoke shave blades are usually ground with a 25° edge angle ( $\alpha$ ).

If you need to work delicate details with a wood chisel in soft wood, you can decrease the edge angle down to 20°.

If you work in hard wood and when using a mallet, you must increase the edge angle to 30°.

