

MICRODIAL™

TAPERING JIG

For use on table saws with the
GRR-RIPPER ADVANCED MODEL GR-200

TJ-5000 Instruction Manual v1.0

Read this manual before use and save
for future reference.

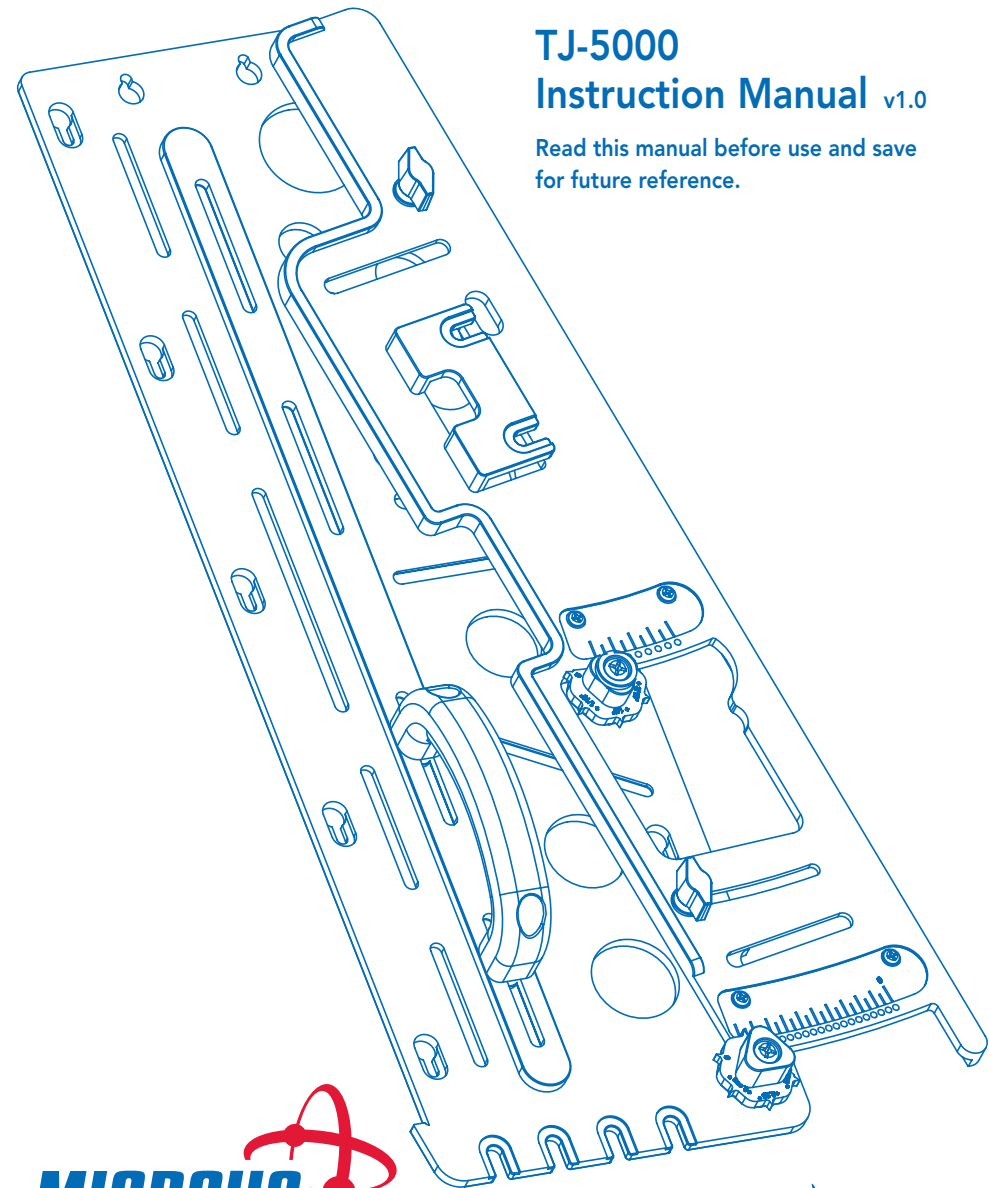

Micro Jig, Inc. • PO Box 195607 • Winter Springs, FL 32719 • USA • MICROJIG.com
MICRODIAL, GRR-RIPPER, COLORMATCH and MEMORYLOCK are trademarks of Micro Jig.
A true Micro Jig innovation. © 2012



MADE IN  THE USA

TABLE OF CONTENTS

Introduction	4-5
Safety Basics	6-7
Getting Acquainted	8-9
Factory Assembled Parts Diagrams	10-11
User Assembled Parts Diagrams	12-13
Using the Degree Scale and MICRODIAL (Option 1)	14-15
Using the Rise and Run Scale and MICRODIAL (Option 2)	16-17
Calibrating the Scales and MICRODIALS	18
Working to a Line (Option 3)	19
Making Tapered Cuts	20-22
Two-Sided Tapering	23
Four and Eight-Sided Tapered Legs	24-25
Setting the MEMORYLOCK System	26
Jointing	27
Safety Warning	28
Project Log	30-31

Congratulations on your purchase of the MICRODIAL™ Tapering Jig. We have put a lot of thought and effort into designing and making what we feel is the safest, most accurate tapering jig available. Before using your jig, read through this booklet to familiarize yourself with the jig and how it works. Here is a general overview of the way the jig was designed to work:

- The jig is designed to work primarily on the table saw although it can be used in a limited capacity on a router table.
- The workpiece must have one straight edge to hold securely against the jig's fence.
- The jig is not meant to be used as a sled: when in use, the workpiece will run directly on the saw's table.
- The jig is designed to be guided along the table saw's rip fence. It does not use the saw's miter gauge slots.
- The jig can be used to make one, two, three, four, and even eight-sided tapers quickly and efficiently.
- While the jig is designed to be used in conjunction with one (or two) **GRR-RIPPER ADVANCED MODEL 3D PUSHBLOCK® (GR-200)** systems (sold separately) it can easily be used alone, particularly with wider workpieces.
- The GRR-RIPPERS attach to the left-hand side of the jig (with the supplied hardware) and provide the secure, safe grip on your workpiece that GRR-RIPPER's are famous for.
- Your jig can be set up in one of three ways: If you know the angle of the taper you want, there is a built-in precision degree scale (accurate to .125°). Our patent-pending **COLORMATCH™** system makes dialing in a precise angle a snap.

- If you know how much taper you want per foot, there is a second precision scale that is calibrated to allow to set up the jig using rise and run measurements.
- Finally, you can also set the jig by simply laying out the taper you are after on the face of the workpiece and adjusting the jig to match.
- With all three of these methods, you can preserve the settings using the jig's built in **MEMORYLOCK™** system.
- Your jig comes mostly preassembled and ready to use. There is also a handful of added hardware for attaching some optional features as well as a fully adjustable handle.
- With minimum care, your new jig should give you years of safe and accurate tapering.

WARRANTY REGISTRATION

Each MICROJIG product includes a one year manufacturer's warranty. Please mail the provided registration card or complete the registration online at [MICROJIG.com/support/warranty-registration/](https://microjig.com/support/warranty-registration/)

RECEIVE THE MICROJIG E-NEWSLETTER

Get the free whitepaper on "4 Easy Ways to Tune-up Your Table Saw" by signing up for the MJ INSIDER, an ongoing email newsletter. Join the smartest woodworkers worldwide today. Go to microjig.com/newsletter and enter your email address. **Work smarter.**

WARNING! Your MICRODIAL Tapering Jig is designed to be used in conjunction with a tablesaw. Make sure you are familiar with the operation of your saw before attempting any of the techniques presented within this manual. MICROJIG Inc. assumes no liability for any product not manufactured by it. The user must take all necessary precautions when operating a tablesaw or any other tools as recommended by their manufacturers and as required by any prudent tool user.

- All components must be thoroughly inspected for damage before use. Stop using the jig if any damage occurs.
- Always wear safety glasses and hearing protection.
- Do not use this jig while under the influence of alcohol, drugs, medication or if you are tired.
- If you are not completely confident in your ability to complete a cut, do not attempt it.
- Make sure your workpiece sits solidly on the saw table and has a straight edge to place in contact with the jig's fence that is securely fastened.
- Keep the saw blade as low as possible to make the cut. The saw teeth should project **no more than 1/4"**
- Make sure the saw's rip fence is locked in place before making any cuts
- Check to make sure the blade will not come into contact with the jig or any part of the GRR-RIPPER PUSHBLOCKs during the cut.
- When using this jig in conjunction with any other tool, make sure you are familiar with the operation of that tool as well.
- It is the sole responsibility of the purchaser to ensure that any third party reads and agrees to all the safety precautions and terms prior to using the jig.
- Remove all jewelry, secure loose clothing, and tie up long hair before using the jig.
- The saw table should be clean and free of obstructions before cutting.
- Make sure the rip fence locks securely in place parallel to the saw blade.
- Only use sharp, clean blades when making tapered cuts. A rip blade or a combination blade (40 tooth or fewer is preferred).
- Prior to making a cut, rehearse the procedure with the blade lowered and power off so you can see exactly how the cut will proceed.
- Refer to the manual that came with your GRR-RIPPER 3D PUSHBLOCKs for more complete information about how to use them safely and effectively.
- Make sure your workpiece is properly loaded into the jig before cutting. It should be tight against the jig's fence, and seated firmly against the heel at the trailing end.
- Tighten the Locking Knob and the Pivot Knob on the jig before cutting.
- Disengage both the degree scale and the rise and run scale before adjusting the jig. Trying to make adjustments with the scales in place may result in damage to the alignment pins.
- Clean up all sawdust from around the base of the saw to keep the floor from being slippery.

GETTING ACQUAINTED

Your MICRODIAL Tapering Jig by MICROJIG comes mostly preassembled and ready to taper. Take a few minutes to look over the photo on the opposite page to familiarize yourself with the various parts and where they are located.

- A** Holes for hanging the jig
- B** Slots for attaching GRR-RIPPERS. Plenty of adjustability for different sizes of work.
- C** GRR-RIPPER mounting hardware. Insert through slots B.
- D** Pivot Knob
- E** MEMORYLOCK™ stops and hardware. Insert through slots G.
- F** Trailing heel (H) storage
- G** MEMORYLOCK™ stop slots
- H** Trailing block and hardware. Store in storage F when not in use. Insert into slots L when use for jointing.
- I** Rise and run scale and MICRODIAL
- J** Locking Knob
- K** Degree scale and MICRODIAL
- L** Slots for mounting the trailing block (H)
- M** Heel Hook
- N** Handle and hardware. Insert through slots O.
- O** Slots for mounting handle (N). Like the slots for mounting the GRR-RIPPERS, there is plenty of room for adjustment.
- P** Keyhole slots for attaching an optional user-made auxiliary sole with wood screws (not included). Please refer to included instructional DVD for further details.

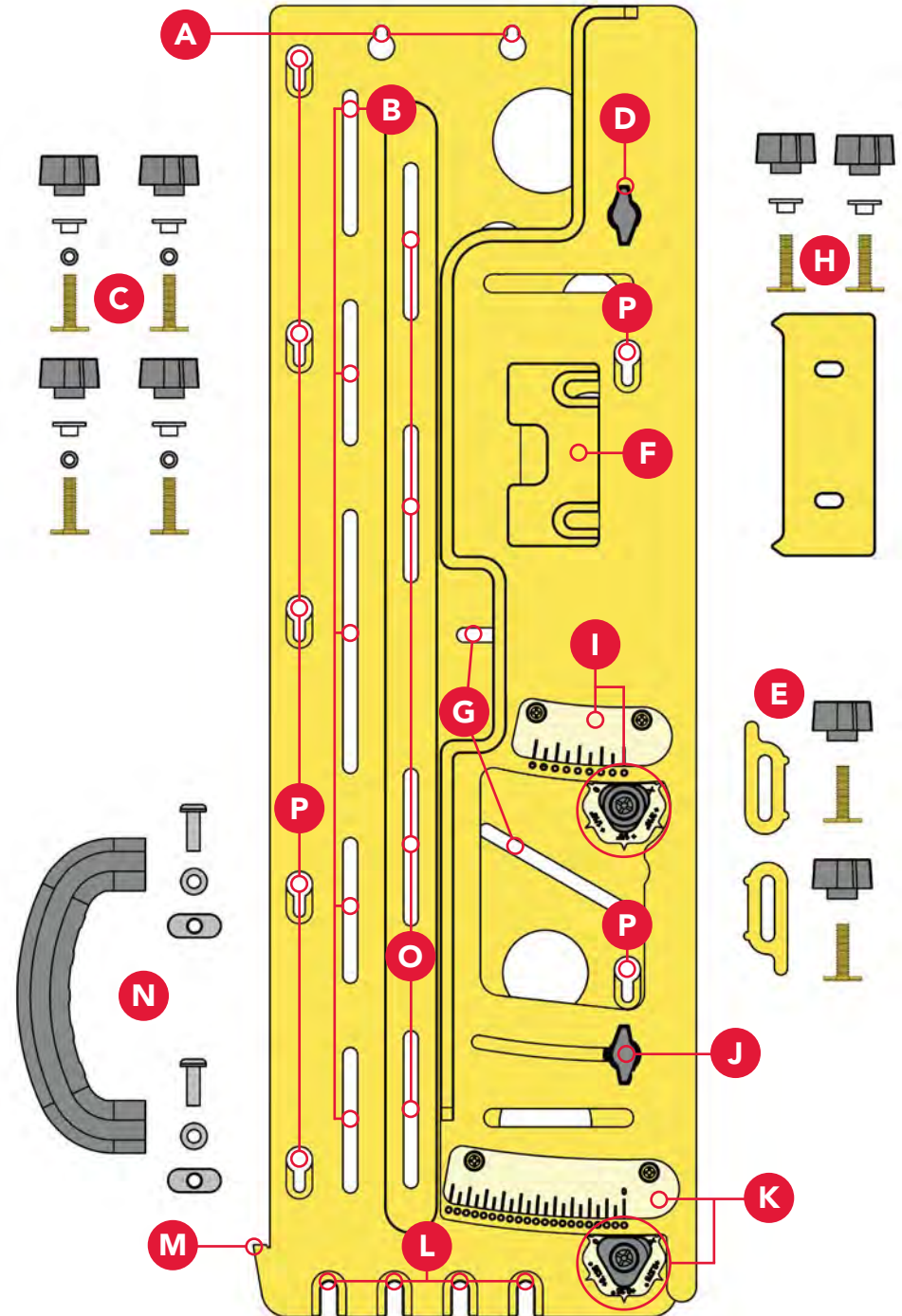

FACTORY ASSEMBLED PARTS DIAGRAMS

FACTORY ASSEMBLED JIG



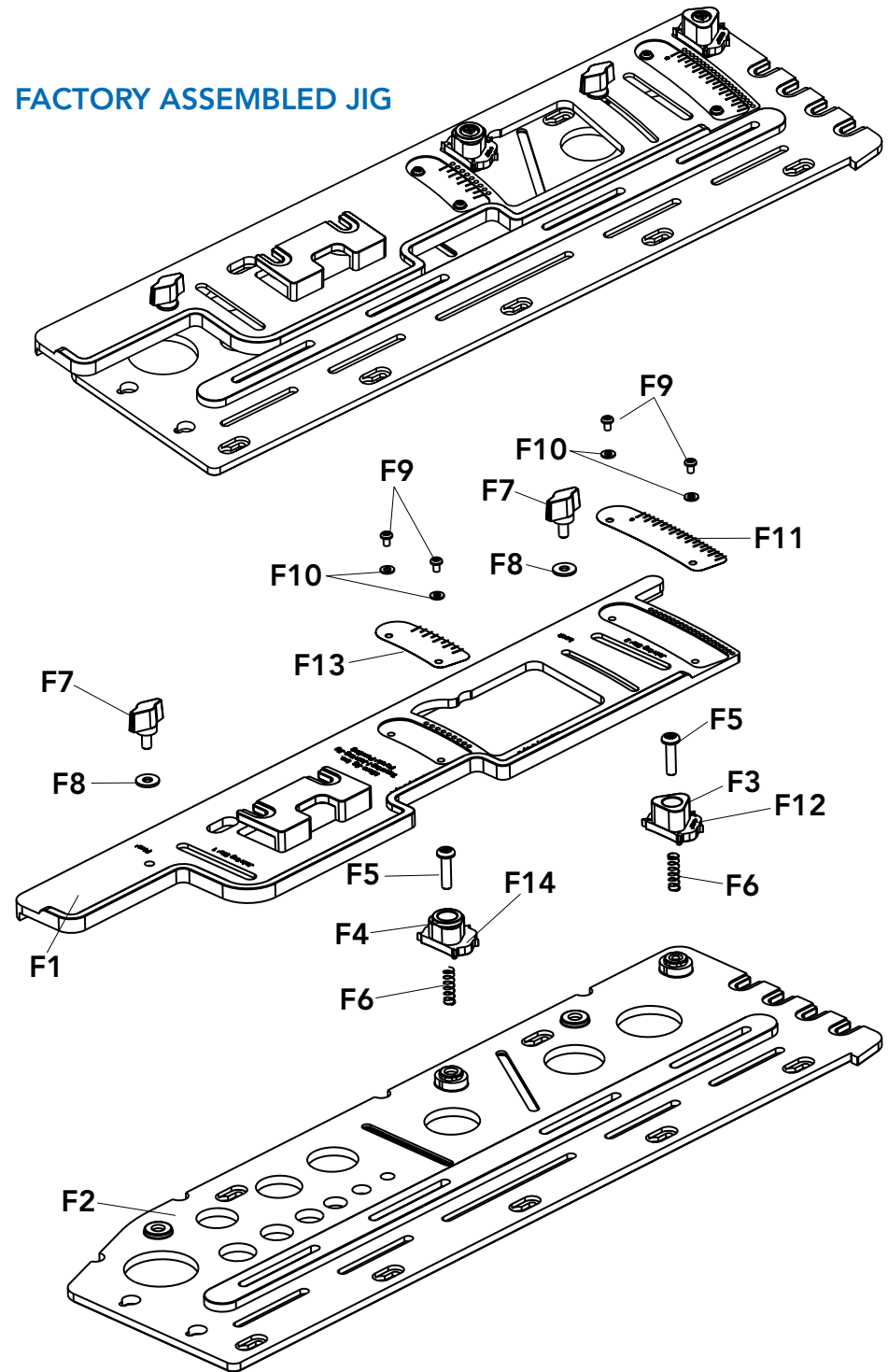

ID	DESCRIPTION	PART #	QTY
F1	Top Plate	TJ-P1	1
F2	Bottom Plate	TJ-P2	1
F3	MICRODIAL Degree	TJ-P3	1
F4	MICRODIAL Rise and Run	TJ-P4	1
F5	1/4-20 x 1" PH Screw, Nylon Patch	TJ-H1	2
F6	Compression Spring	TJ-H2	2
F7	1/4-20 Thumb Screw	TJ-H3	2
F8	1/4 x 5/8 Flat Washer	TJ-H4	2
F9	#8 x 1/4" PH Screw	TJ-H5	4
F10	#8 Washer	TJ-H6	4
F11	Degree Scale	TJ-H14	1
F12	Degree Dial Marker (over mold)	TJ-H15	1
F13	Rise and Run Scale	TJ-H16	1
F14	Rise and Run Dial Marker (over mold)	TJ-H16	1







USER ASSEMBLED PARTS DIAGRAMS

NOTE: Please check if you have all the parts and hardware before assembling.

HARDWARE PARTS LIST - YELLOW BAG (USER ASSEMBLY)

ID	DESCRIPTION	PART #	QTY
U1	 Memory Stop	TJ-P5	2
U2	 Trailing Block	TJ-P6	1
U3	 1/4-20 Thumb Knob	TJ-H8	8
U4	 Shoulder Washer	TJ-H9	6
U5	 5/16 OD O-Ring	TJ-H10	4
U6	 1/4-20 x 1" T-Bolt	TJ-H7	8

HANDLE & HARDWARE (USER ASSEMBLY)

ID	DESCRIPTION	PART #	QTY
U7	 Handle	GR-P1	1
U8	 1/4-20 x 3/4" PH Screw	GR-H10	2
U9	 1/2" OD Washer	GR-H2	2
U10	 1/4-20 Oval Nut	GR-H7	2

FULLY ASSEMBLED MICRODIAL TAPERING JIG

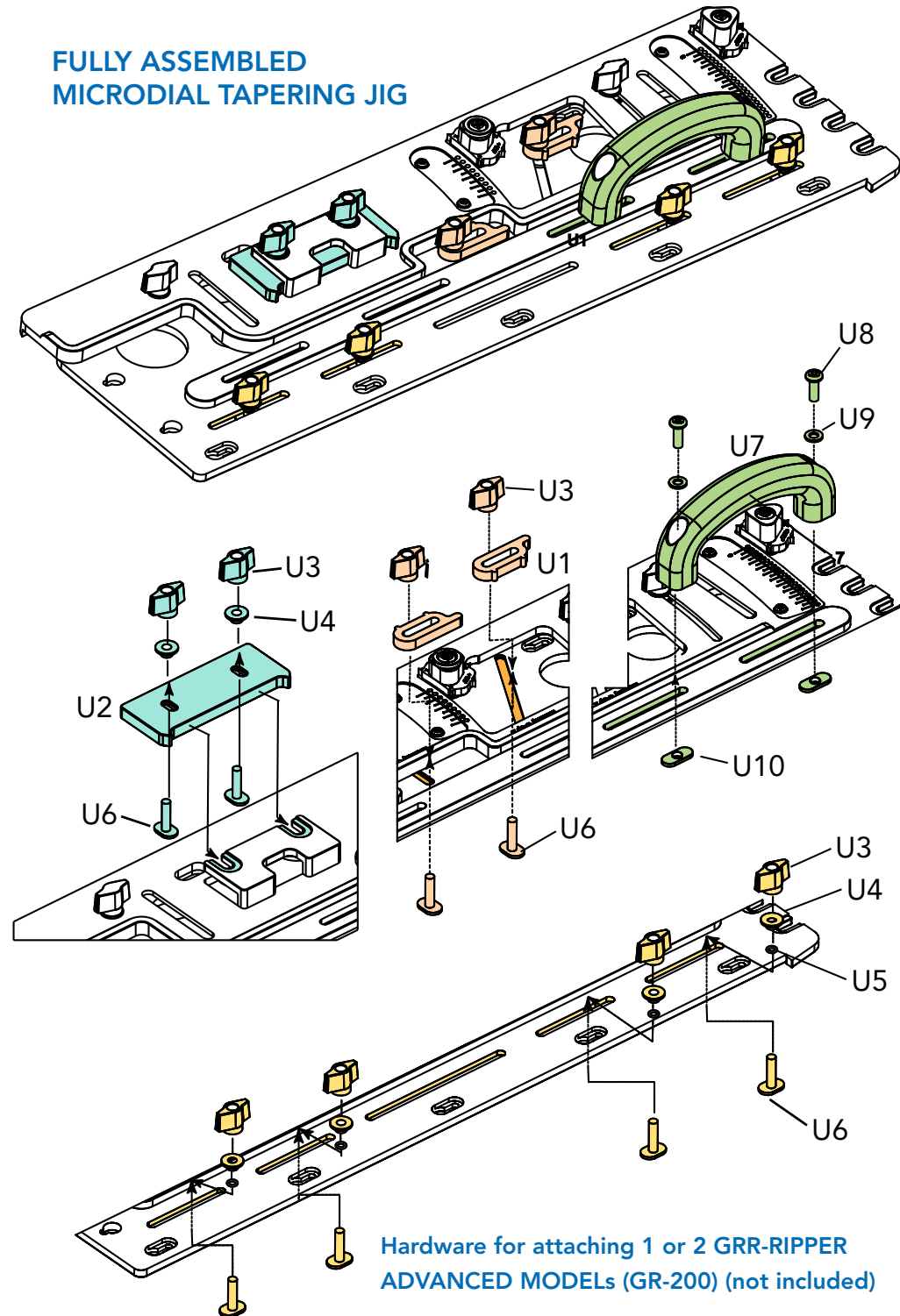

Hardware for attaching 1 or 2 GRR-RIPPER ADVANCED MODELS (GR-200) (not included)

USING THE DEGREE SCALE AND MICRODIAL

(OPTION 1)

One way tapers are often specified is by degrees. This is especially true if you are cutting compound miters. Your MICRODIAL Tapering Jig is incrementally adjustable for tapers between 0° and 10°. The COLORMATCH™ system consists of the color-coded adjustment dial and degree dial, which are designed to make it easy to precisely set angles in 1/8° (.125°) increments. The photos that follow show exactly how to use these to achieve the precise angles you need. **NOTE:** See page 16 if the scales don't line up with the pointer.

1. Start by determining what angle (in degrees) you need. This may be specified on your plans, or you can draw the taper on your piece and measure it.



2. To set the scale, lift up on the adjustment knob and pivot it. For whole and half degrees, use the pointer marked with the red 0. Notice how those marks on the scale are also in red. When you release the knob, a pin will engage one of the holes in the scale for precise alignment. Here, the jig is set to make a 3° taper.

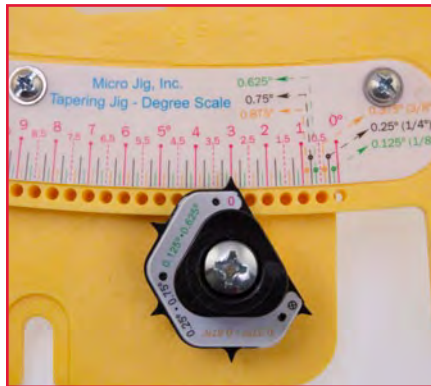

3. Use the green lines along with the pointer marked with green numbers for 1/8° and 5/8° (.125° and .625°) angles. Here the jig is set for 3 1/8° (3.125°). As long as you follow the COLORMATCH, it is nearly impossible to go wrong.



4. The black lines and numbers are for the 1/4° and 3/4° (.25° and .75°) settings, and the yellow lines and numbers are for the 3/8° and 7/8° (.375° and .875°) settings. Here the jig is set for 3 1/4°.



5. For angles that fall in between the eighths, use the pointer marked with a black X inside a circle. There is no pin associated with this pointer, so the jig will pivot freely.



USING THE RISE AND RUN SCALE AND MICRODIAL

(OPTION 2)

Another way tapers are often specified is by rise and run (a certain amount of taper over a specified length). Your MICRODIAL Tapering Jig also includes a scale for this. This COLORMATCH rise and run dial and scale are calibrated to allow you to set up tapers ranging from 0" to 2" per foot.

1. Lay out the taper on your workpiece. Note the rise (width) and the run (length) of the taper in inches. To calculate the rise per foot, plug the numbers into this formula:

$$\frac{\text{Rise} \times 12}{\text{Run}} = \text{Rise per foot}$$

Ex: A leg that tapers 3/8" in 18" has a taper of 1/4" per foot.

$$\frac{3/8 \times 12}{18} = 1/4$$



2. To set the jig for the 1/4" inch divisions (0, 1/4", 1/2", 3/4", 1" etc.), pull up on the knob and align the pointer near the red 0 with the appropriate red line on the scale. When the dial is aligned properly, a pin underneath will drop the appropriate hole. Here the jig is set to cut a taper of 1" per foot.



3. To set the jig for the 1/8" inch divisions (1/8", 3/8", 5/8", 7/8"), align the pointer near the black numbers with the appropriate black line on the scale. Here the jig is set to cut a taper of 1 1/8" per foot.

NOTE: The numbers refer to the number of sixteenths in each eighth.



4. For the sixteenths, use either the pointer near the yellow or green numbers aligned with the yellow or green lines respectively. Here the jig is set to cut a taper of 1 3/16" per foot.



5. For tapers that don't work out to even sixteenth inch increments, use the pointer marked with a black X inside a circle. There is no pin associated with this pointer, so the jig will pivot freely. Here the jig is set to cut a taper just under 1 1/4" per foot.



MAKING TAPERED CUTS

Once you have your MICRODIAL Tapering Jig set (pages 12-17) it is time to attach your GRR-RIPPER 3D PUSHBLOCKS and make the cut(s). The jig is designed to work with one (or for longer pieces, two) GRR- RIPPERs ADVANCED MODEL (GR-200). GRR-RIPPERs provide both a secure grip on your workpiece as well as handles to keep your fingers protected from the blade. When the GRR-RIPPERs are attached to the jig, extremely safe and accurate tapers are possible.

1. Attach your GRR-RIPPER to the jig with the included T-bolts and knobs. These engage the slots in the GRR-RIPPER's Balance Support. Be sure the Balance Support is fully inserted under the knobs and doesn't stick out past the edge of the tapering jig. You may need to experiment a little with the front and back positioning to make sure the GRR-RIPPER isn't in line with the cut.



2. Adjust the GRR-RIPPER's Center Leg laterally so it rests firmly on the workpiece, but off to one side of the cut line. It helps to have the cut line drawn on your piece so you can clearly see where the cut will be. **NOTE:** If necessary, the Center Leg can be removed from the GRR- RIPPER if it cannot be positioned off of the cut line.



3. For narrow pieces, such as table legs, the outside leg of your GRR-RIPPER may hang out beyond the edge of the workpiece. In this case, add the GRR-RIPPER's Adjustable Spacer along with a user-made riser block for extra support. Riser block size and dimension will vary depending on the dimensions of your workpiece. Press down firmly on the GRR-RIPPER. Tighten the knobs to ensure the GRR-RIPPER has good traction.



4. With the spacer in place, adjust the rip fence so the blade enters the workpiece where you want the taper to begin. Make sure the workpiece is against the jig's edge and butted against the heel at the rear. Align the taper starting line on the table leg to the front tip of the saw blade, or draw a reference line on the throat plate as a alignment line. **NOTE:** Raise the saw blade no more than 1/4" (.25") above the surface of the workpiece. Ensure that the saw blade passes through the GRR-RIPPER tunnel.

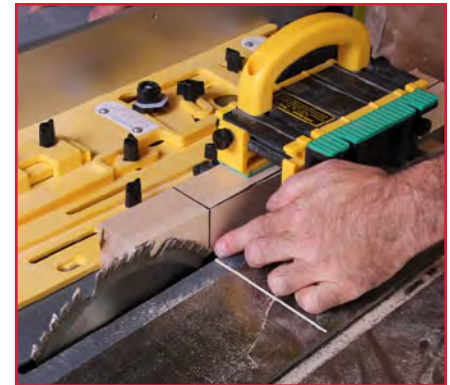

5. Guide the jig along the fence to make the cut, keeping both hands on the handles. As the cut progresses, you can shift your grip from handle to handle depending on what feels comfortable.



6. On most tapered legs, the two tapered sides are adjacent to each other. This means the leg will be thinner after you rotate it to get ready to make the second cut. To compensate for this, loosen the knobs on the sides of the GRR-RIPPER and push it down so it makes firm contact with the leg. Tighten the knobs to lock the GRR-RIPPER in place.



7. For longer workpieces, adding a second GRR-RIPPER gives you increased control. Tie the two GRR-RIPPERs together with a longer riser block. Just make sure both GRR-RIPPERs will clear the blade.

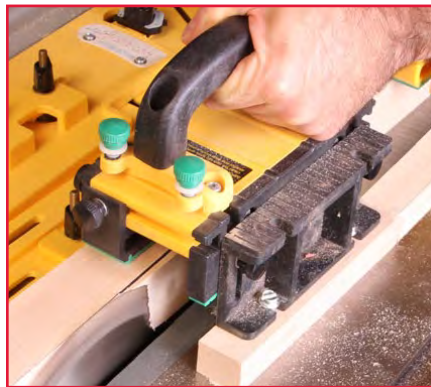

SAFETY ALERT! When making a second cut on a tapered piece, the trailing end of the leg will be thinner than the leading end. Make sure the blade isn't set so high that it will cut into the underside of the GRR-RIPPER at the end of the cut. Move the GRR-RIPPER forward if necessary.



If your project calls for a piece that is tapered equally on opposite sides, you will need to reset your MICRODIAL Tapering Jig in between the cuts. After you make the first cut, you have changed the reference surface for the second cut. Reset the jig by doubling the initial setting as shown in the photos below. **Note:** On wider workpieces, you can use the tapering jig without GRR-RIPPERS.

1. Lay out both tapers on your workpiece. Set the jig to make the first cut. The taper here is 3°. Secure the piece the table with your hand. Keep fingers clear of blade. Make the cut.

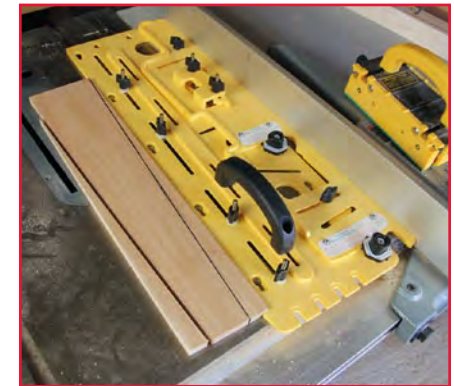

2. To cut the second side, flip the piece over so the side you just cut is against the jig. Lay out the second cut. Reset the jig to double (2X) the setting for the first cut. Here the setting is for 6°. Secure the piece the table with your hand. Keep fingers clear of blade. Make the cut. **Note:** You may need to adjust the rip fence to align the saw blade to the starting point of the second taper.

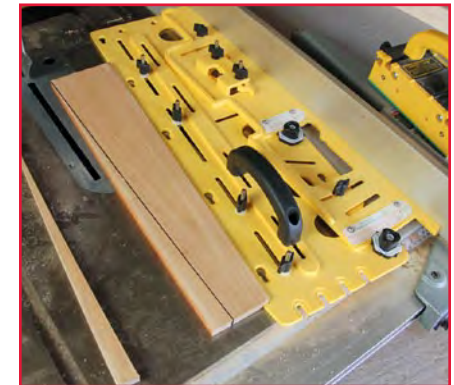

FOUR AND EIGHT-SIDED TAPERED LEGS

Making a piece with a four-sided taper is little different than making one with a two-sided taper. Make the first two cuts on two adjacent sides of the piece, then reset your MICRODIAL Tapering Jig to cut the final two sides. For an eight-sided (octagonal) taper, you'll change the jig setting a third time and tilt the blade on your table saw. Despite all the different settings, the precision scales on your MICRODIAL Tapering Jig make this entire process quite easy, and very repeatable.

1. Set up the jig to make the first two cuts. In this case, the jig was set to cut 1/4" per foot. Adjust the rip fence so the taper starts at the right point. Cut the first side. Then rotate the piece so the cut side is up and cut the second side.



2. For the 3rd and 4th sides, reset the jig for twice the amount of desired taper (here 1/2" per foot) to compensate for the cuts you just made. You may need to reset the fence slightly to have the taper start in the right place. The example required approximately a 1/16" adjustment. Notice the beginning of the taper indicated by the marker line is inline with the beginning of the saw blade or the reference line drawn on throat plate.



3. For eight-sided tapers, taper all 4 sides of the leg then tilt the saw blade to 45-degrees and reset the jig to the desired rise and run or degree. Notice the bigger the angle will result in a steeper taper cut. Use your best judgment on the style and design of your tapers. In the example image, the piece tapers to an octagon at the bottom, so the setting was 3 times the original taper of 3/4" per foot. Reset the fence to have the taper start in the desired place.



4. Make the tapers as usual, rotating the piece clockwise after each cut.
NOTE: if you are using a right-tilt saw, Pay close attention to where the blade is as you will be cutting along the upper corner of the workpiece.



5. Eight-sided tapers can lend an air of real elegance to a table leg. Experiment on some spare pieces to see what other forms you can create.



The MEMORYLOCK system allows for quickly shifting between two preset tapers for repeatable cutting. Use the two MEMORYLOCK Stops to memorize two individual tapers.

1. Set the MEMORYLOCK Stop for the shallower angle in the slot near the center of the jig. Position the stop so the two small nubs rest against the edge of movable portion of the jig and tighten the knob. Make sure the long nub is facing down toward the bottom of the jig.



2. For the steeper taper, set up the MEMORYLOCK Stop in the angled slot towards the rear of the jig. Again adjust the stop so the two nubs touch the edge of the movable part of the jig. With the stops set, you can switch between them by simply loosening the locking knob and pivoting the bottom plate.



The MICRODIAL Tapering Jig may be used as a large pushblock to straighten the edge of crooked boards on your tablesaw. Attach the Trailing Block and shift the jig's Top Plate to the Jointing Slots. The MICRODIAL Tapering Jig can straighten the edges of boards up to approximately 12" wide and 30" long.

1. Attach the Trailing Block to the back slots of the jig using the bolts. Make sure the pointed nubs are facing toward the front of the jig. The pointed nubs create even contact for rough or uneven lumber.



2. Unbolt the Top Plate from the Pivot and Locking Knobs. Shift 1" forward and reattach it through the two Jointing Slots. In this position the Top Plate can slide laterally to accommodate wider boards.



3. To make the cut, hold the jig on top of your workpiece with the Trailing Block hooked on the trailing end of the board. Guide the jig along the fence, pushing the board as you go. For even more support, add one or two GRR- RIPPER GR-200s.



SAFETY

SAFETY WARNING! When tapering two adjacent sides of a piece, be aware of the blade height when making the second cut. This is critical if your taper exceeds 1/2" per foot. As shown in the photos below, even if the blade is barely above the surface of the piece at the beginning of the cut, it can come dangerously close to the GRR-RIPPER at the end. Take the time to check this out before turning on the power. If necessary you can shift the GRR-RIPPER(s) forward to create additional clearance. In extreme cases, remove the rear GRR-RIPPER to eliminate risk of the blade cutting into its underside.

1. In this example, the workpiece tapers from 1 5/8" at the leading end to 1/2" at the trailing end, (taper of 9/16" per foot over 24"). Here, the blade is set just barely above the stock surface.



2. At the trailing end, the blade is significantly above the stock surface and just barely clears the underside of the GRR-RIPPER. In this case, shifting the GRR-RIPPER forward provides just enough clearance for a safe cut.

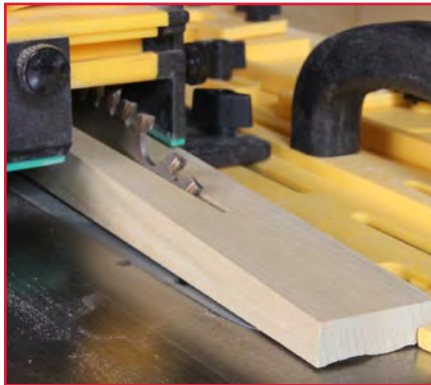

PROVEN SAFETY, PRECISION & CONTROL.



To learn more about MICROJIG's brands, watch our product demonstration videos available on MICROJIG.com. *Work smarter.*

GRR-RIPPER®

The Ultimate 3D Pushblock® for preventing kickback, saving fingers, and precision cutting.

"These are **AMAZING** results and it gives you the opportunity to say that 100% and 10 out of 10 DIYers approve and recommend the product!"

— Ross Tanner,
Product Test Editor,
HANDY Magazine



ZEROPLAY®

The only One-Touch Calibration® Miter Bar for woodworking sleds, jigs, and fixtures.



MJ SPLITTER™

The easy to install, easy to use, and easy to align table saw safety splitter.



Project Name: _____ Date _____

Wood Species _____

Number of Legs _____

Leg Dimensions:

Example:

Thickness 2" Width 1.5" Length 25"

My Project:

Thickness _____ Width _____ Length _____

**Saw Blade Height: Always set the blade height at 1/4" above stock.
Different blade height affects Fence Setting.**

Taper Surface	Taper starts inches from top	Taper Degree or inch/foot	Fence Setting	Blade Angle
Example	5"	1.25° or 3/16"	10.25"	90°
Side 1 Settings				
Side 2 Settings				
Side 3 Settings				
Side 4 Settings				
Side 5 Settings				
Side 6 Settings				
Side 7 Settings				
Side 8 Settings				

TAPERED LEG EXAMPLES

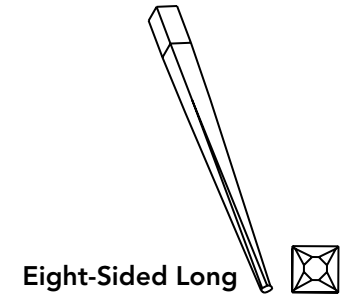
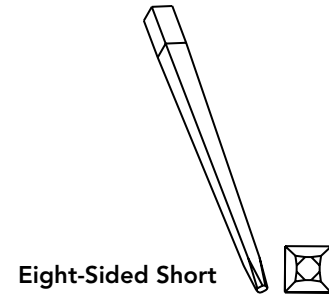
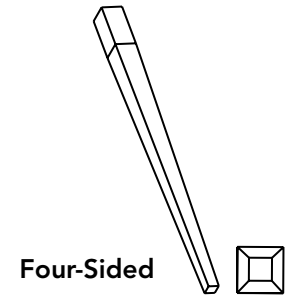
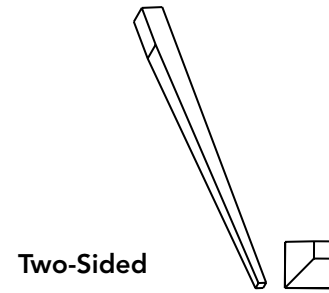

RISE AND RUN CALCULATION

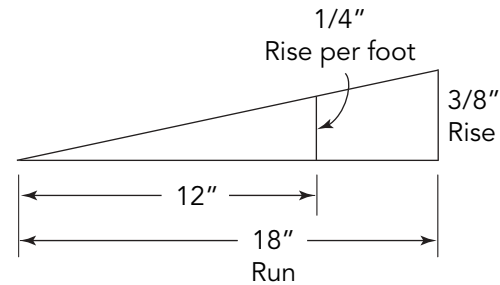

Drawing for illustration purposes (not to scale)

$$\frac{\text{Rise} \times 12}{\text{Run}} = \text{Rise per foot}$$

Ex: A leg that tapers 3/8" in 18" has a taper of 1/4" per foot.

$$\frac{3/8 \times 12}{18} = 1/4$$

In this example, set the Rise and Run MICRODIAL to 1/4" to achieve 3/8" taper in 18"